

Radialux® RGBW Neon 100 SB (Side-Bending)

Actual size shown



Radialux 24V Neon tape light is the next generation of color-changing, flexible linear LED lighting made from silicone for increased flexibility. It can be used indoors and outdoors for dynamic, curved lighting installations. A rugged, ultra-flexible silicone housing provides protection, longevity, and 100% hotspot-free lighting.

- Medium output
- Industry-leading 95+ CRI (Color Rendering Index)
- Mix of white and RGB light provides both pastel and saturated color possibilities
- 5-year warranty

Radialux RGBW Neon 100 SB shines from the top and bends to the sides.

TECHNICAL INFORMATION

Color	RGBW
Power Consumption per Foot	4.39 Watts
Input Voltage	24V DC
Tape Height	0.67 inches
Tape Width	0.47 inches
Beam Angle	120°
Bend Radius	>2.36 inches
Field Cuttable (UL 2108)	Every 2.46 inches
Color Temperature	2700K

Maximum Run Length	16.4 ft.
Dimmable	Yes (with color controller)
Ambient Temperature	-4° F to 113° F
Spool Lengths	16.4 ft.
Environment	Indoor/Outdoor, Dry/Wet, IP67
Certifications	UL Listed, UL 2108, CE, RoHS
UV Rating	No discoloration
Warranty	5 Year Limited

*Each tape light section includes 18 in. right-hand lead wire with spliced ends on one end and 18 in. left-hand lead wire with spliced ends on other end.

PRODUCT INFORMATION

Item Number	Length	Voltage	CRI	Lumens	Color Temperature
AL-02-71-2401-SB	16.4 ft.	24V DC	95	77	2700K

DIMENSIONS AND BEND RADIUS

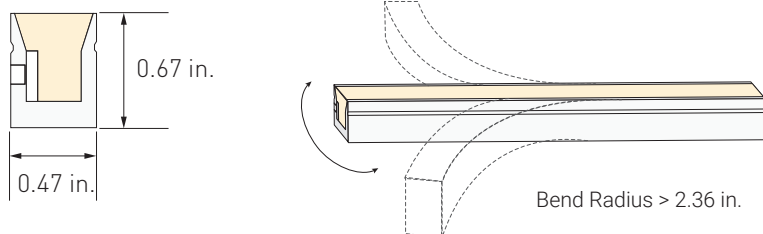

VOLTAGE DROP GUIDANCE CHART

Standard Non-XT 24V Voltage Drop and Wire Length Distance Chart (3% Drop or 24V)

Wire Gauge	Copper Wire Resistance (Ω/kFT)	10W (0.42A)	20W (0.83A)	30W (1.25A)	40W (1.67A)	50W (2.08A)	60W (2.50A)	70W (2.92A)	80W (3.33A)	90W (3.75A)	96W (4A)
22 AWG	16.14	54 ft.	27 ft.	18 ft.	14 ft.	11 ft.	9 ft.	8 ft.	7 ft.	6 ft.	6 ft.
20 AWG	10.15	86 ft.	43 ft.	29 ft.	22 ft.	18 ft.	15 ft.	13 ft.	11 ft.	10 ft.	9 ft.
18 AWG	6.39	136 ft.	68 ft.	46 ft.	34 ft.	28 ft.	23 ft.	20 ft.	17 ft.	16 ft.	15 ft.
16 AWG	4.02	216 ft.	108 ft.	72 ft.	54 ft.	44 ft.	36 ft.	31 ft.	27 ft.	24 ft.	23 ft.
14 AWG	2.53	343 ft.	172 ft.	115 ft.	86 ft.	69 ft.	58 ft.	49 ft.	43 ft.	39 ft.	36 ft.
12 AWG	1.59	545 ft.	273 ft.	182 ft.	137 ft.	109 ft.	91 ft.	78 ft.	69 ft.	61 ft.	57 ft.
10 AWG	0.99	865 ft.	433 ft.	289 ft.	217 ft.	173 ft.	145 ft.	124 ft.	109 ft.	97 ft.	91 ft.

Note: These tables provide general guidelines for determining Wire Gauge based on total load and distance from LED driver to beginning of luminaire.

COMPATIBLE CONNECTORS

Mounting Accessories

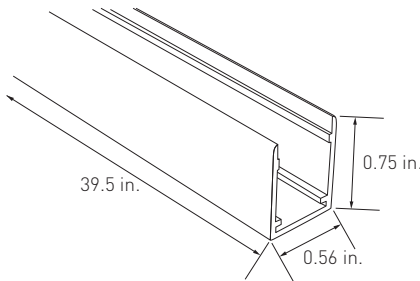

Aluminum Mounting Track
AL-02-71-9923-AL (39.5 in.)

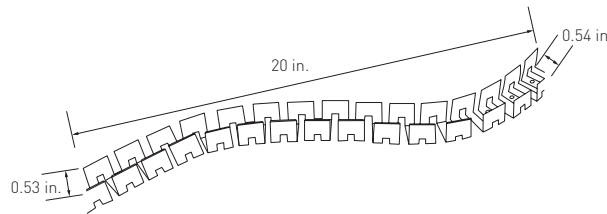

Flexible Mounting Track
AL-02-71-9930 (20 in.)

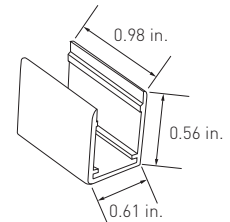

Aluminum Mounting Clip/Screws
AL-02-71-9981 (1-pack)
AL-02-71-9986 (10-pack)

Other Accessories

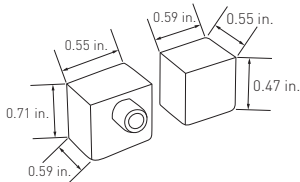

Silicone End Caps - Left/Right
AL-02-71-9961 (1-pack)
AL-02-71-9966 (10-pack)

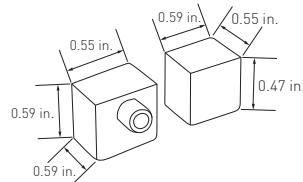

Silicone End Caps - Straight
AL-02-71-9961-DS (1-pack)
AL-02-71-9966-DS (10-pack)

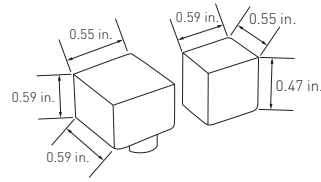

Silicone End Caps - Bottom
AL-02-71-9961-BS (1-pack)
AL-02-71-9966-BS (10-pack)

ALLOY LED® Specifications

ACCESSORIES (SOLD SEPARATELY)

Recommended Accessories

See our website for the full range of RGB/RGBW controllers and accessories.

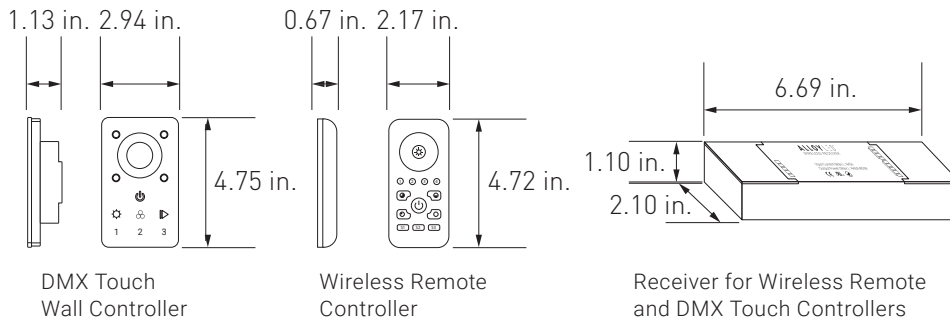

Item Number	Description
AL-60-03-0002*	Wireless Remote Controller
AL-60-03-0003*	DMX Touch Wall Controller
AL-60-03-0004-V2	Receiver for Wireless Remote and DMX Touch Controllers

*Use with the Wireless Receiver AL-60-03-0004-V2 (sold separately)



Mean Well Non-Dimmable Drivers

Item Number	Voltage	Wattage	Dimensions
AL-98-04-24036	24V DC	36W	5.83 x 1.58 x 1.18 in.
AL-98-04-24060	24V DC	60W	6.4 x 1.67 x 1.26 in.
AL-98-04-24100	24V DC	100W	7.5 x 2 x 1.46 in.
AL-98-04-24151	24V DC	151W	7.52 x 2.5 x 1.48 in.
AL-98-04-24200	24V DC	200W	8.47 x 5.43 x 1.18 in.

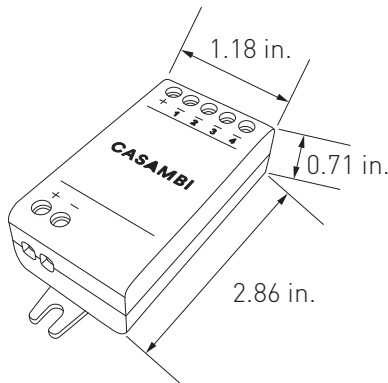

Casambi CBU-PMW4-4 Dimmer

Item Number	Description
AL-60-04-0003	CBU-PMW4-4 Dimmer for PrimaLine Tape Light and Color-Controller for RGBWLight

ALLOY LED® Specifications

RECOMMENDED POWER SUPPLIES (SOLD SEPARATELY)



Alloy LED PowerFactor™ Non-Dimmable Power Supplies with Integrated UL Listed Junction Box
 Reliable, efficient low voltage power to RGB and RGBW color controllers and for use with white tape light on an on/off switch

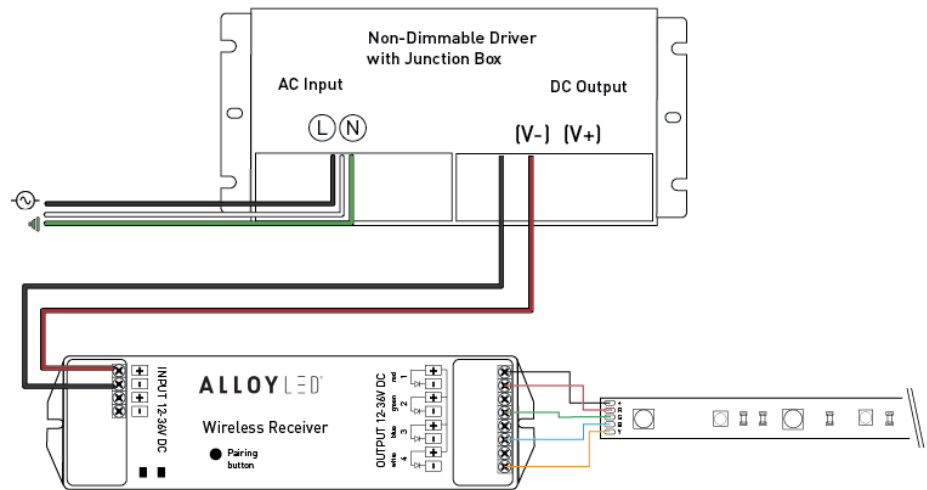

Wiring diagram is for reference only. Please refer to dimmer wiring specifications sheet for accurate directions.

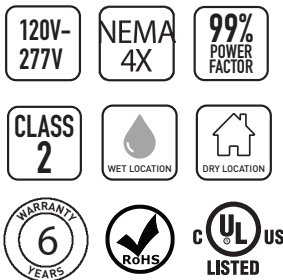

Item Number	Output Voltage	Wattage	Wet Location	Minimum Load	Dimensions (Junction box) (L x W x H)	Class 2
AL-98-12-24030	24V DC	30W	Yes (NEMA 4X)	10%	6.5 x 3.72 x 1.57 in.	Yes
AL-98-12-24060	24V DC	60W	Yes (NEMA 4X)	10%	7.4 x 3.72 x 1.57 in.	Yes
AL-98-12-24080	24V DC	80W	Yes (NEMA 4X)	10%	8.66 x 3.72 x 1.57 in.	Yes
AL-98-12-24096	24V DC	96W	Yes (NEMA 4X)	10%	8.66 x 3.72 x 1.57 in.	Yes
AL-98-12-24192-MT	24V DC	2*96W	Yes (NEMA 4X)	10%	10.94 x 4.25 x 1.77 in.	Yes
AL-98-12-24288-MT	24V DC	3*96W	Yes (NEMA 4X)	10%	11.85 x 4.25 x 1.77 in.	Yes

Note: Alloy LED strongly recommends using Listed Class 2 power supplies for all installations. Always install in accordance with local and national electrical code regulations. Inspectors prefer power supply to be used with junction box. For dimmer compatibility, refer to drivers specification sheet.

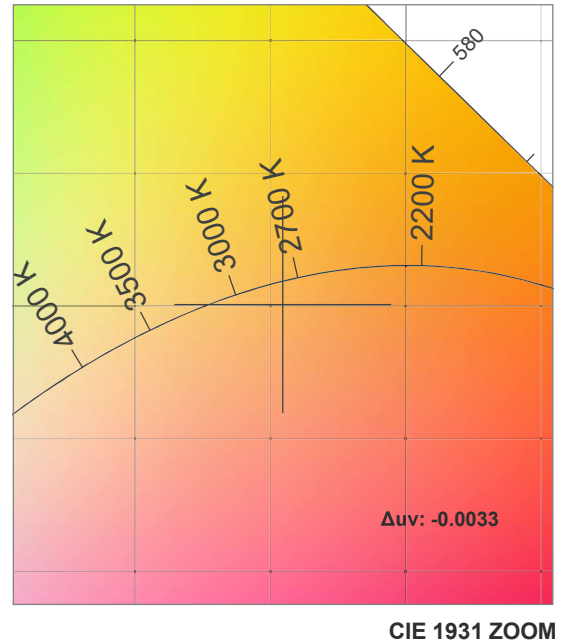
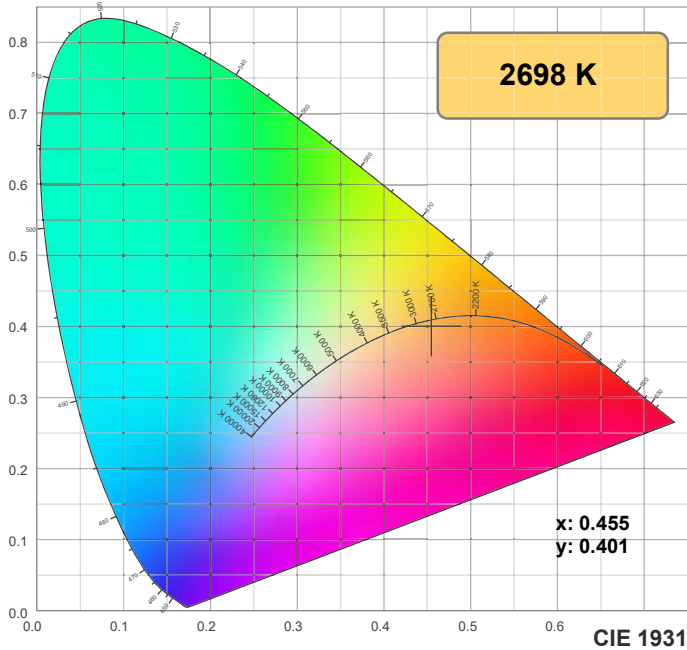

TM30: 91.9

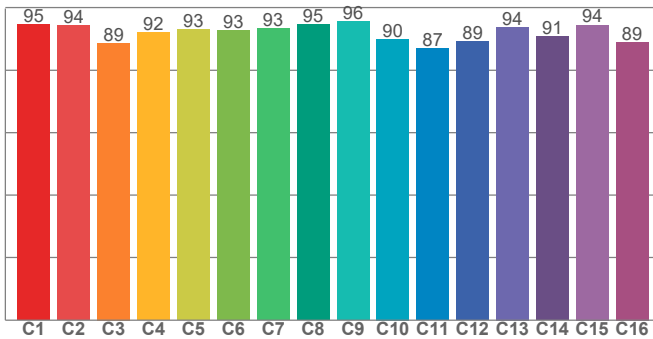

CRI: 95.0 (R1-R8)

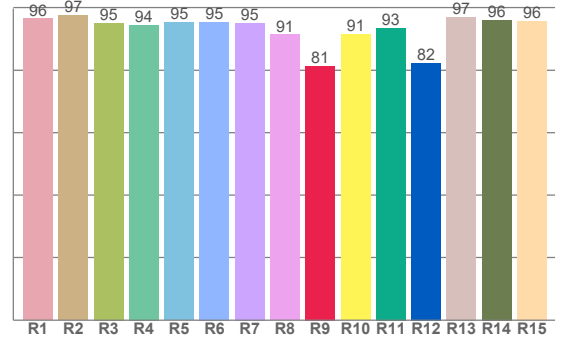

CRI R values, only R1-R8 are used to calculate final CRI value

R1	R2	R3	R4	R5	R6	R7	R8	R9	R10	R11	R12	R13	R14	R15
96.4	97.5	95.0	94.4	95.2	95.3	95.1	91.3	81.3	91.4	93.4	82.3	96.9	96.0	95.7

TM30 C values, 16 binned values out of total of 99 C values

C1	C2	C3	C4	C5	C6	C7	C8	C9	C10	C11	C12	C13	C14	C15	C16
94.6	94.2	88.6	92.0	93.0	92.7	93.2	94.6	95.5	90.0	87.0	89.1	93.7	90.8	94.5	88.9

CQS Q values

Q1	Q2	Q3	Q4	Q5	Q6	Q7	Q8	Q9	Q10	Q11	Q12	Q13	Q14	Q15
92.6	96.6	85.2	85.3	90.2	90.3	85.6	89.1	96.0	91.0	90.0	90.5	92.0	92.3	92.3

CQS: 89.9

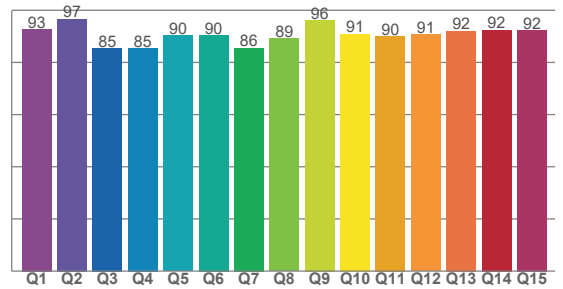

Color parameters

Color temperature	Color rendering index	Red component	Color fidelity	Color gamut	Color quality scale	Color coordinate cie 1931	Color coordinate cie 1931	Color coordinate	Color coordinate	Color deviation from black body
CCT	CRI	CRI R9	TM30 Rf	TM30 Rg	CQS	x	y	u	v	Δuv
2698 K	95.0	81.3	91.9	102.5	89.9	0.455	0.401	0.264	0.348	-0.0033

Rf 91.9
Fidelity index Rf

Rg 102.5
Gammut index Rg

Hue Bin	Graphic shifts (%)		
	R _f	Chroma	Hue
1	95	-3%	0%
2	94	-2%	3%
3	89	0%	6%
4	92	1%	4%
5	93	3%	3%
6	93	5%	0%
7	93	2%	-3%
8	95	-1%	-3%
9	96	-2%	1%
10	90	-2%	6%
11	87	1%	10%
12	89	5%	4%
13	94	4%	-1%
14	91	6%	-4%
15	94	1%	-3%
16	89	1%	-9%

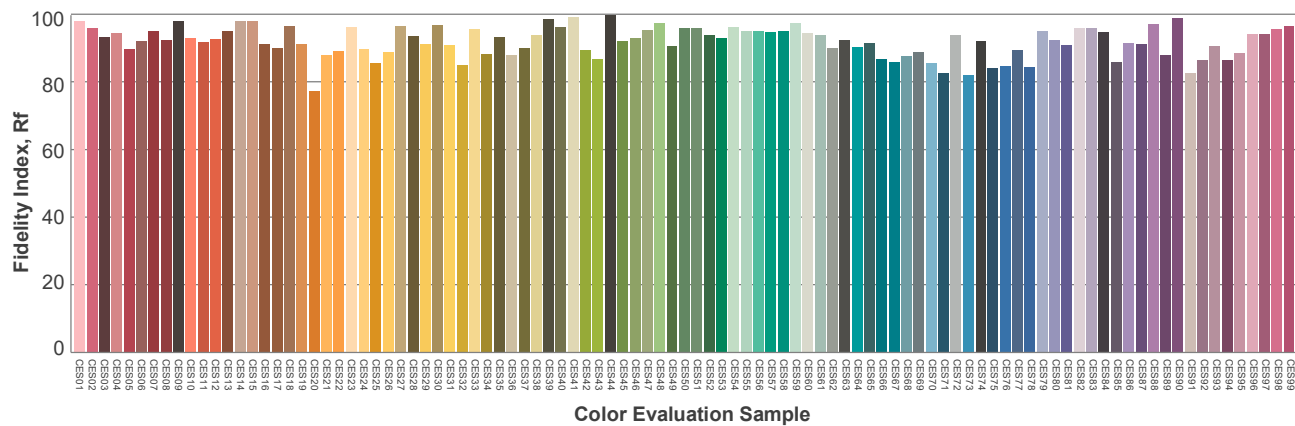
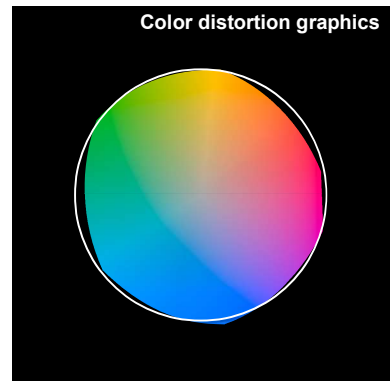
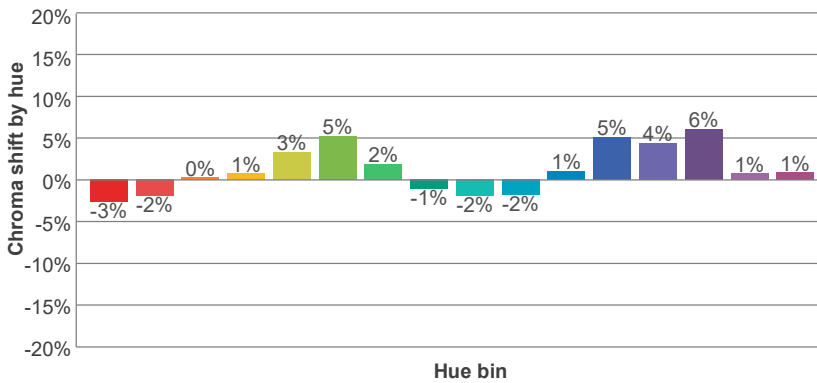
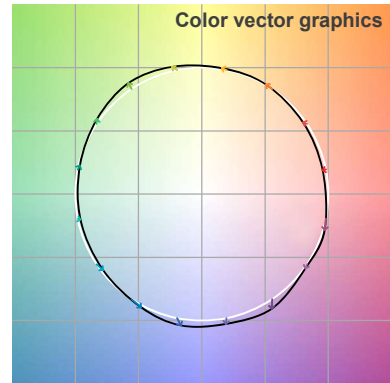
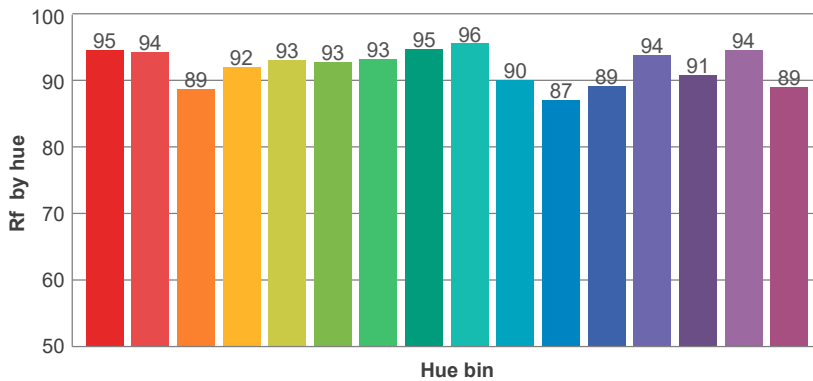
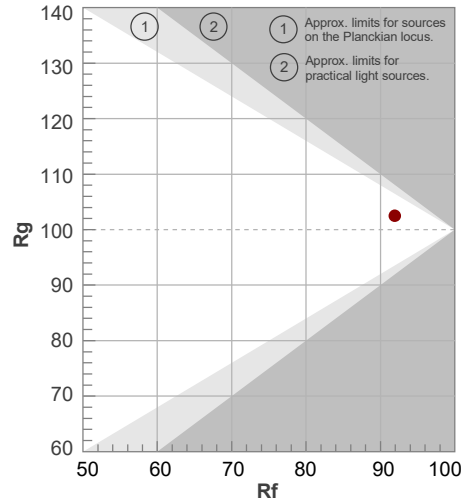

ALLOY LED® Specifications

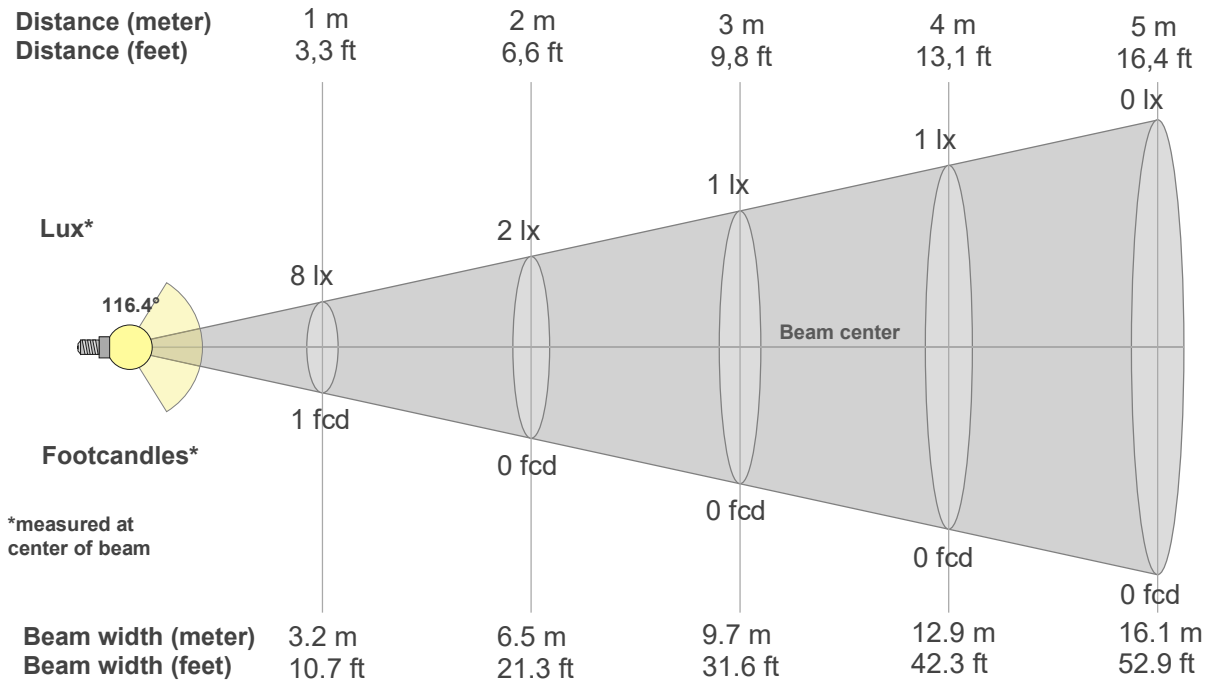

Beam intensities from 1-20m

1m	2m	3m	4m	5m	6m	7m	8m	9m	10m	11m	12m	13m	14m	15m	16m	17m	18m	19m	20m
3.3ft	6.6ft	9.8ft	13.1ft	16.4ft	19.7ft	23ft	26.2ft	29.5ft	32.8ft	36.1ft	39.4ft	42.7ft	45.9ft	49.2ft	52.5ft	55.8ft	59.1ft	62.3ft	65.6ft
8lx	2lx	1lx	1lx	0lx	0lx	0lx	0lx	0lx	0lx	0lx	0lx	0lx	0lx	0lx	0lx	0lx	0lx	0lx	0lx
0.8fcd	0.2fcd	0.1fcd	0fcd	0fcd	0fcd	0fcd	0fcd	0fcd	0fcd	0fcd	0fcd	0fcd	0fcd	0fcd	0fcd	0fcd	0fcd	0fcd	0fcd

Intensities in 0° c-plane

0°	9°	18°	27°	36°	45°	54°	63°	72°	81°	90°	99°	108°	117°	126°	135°	144°	153°	162°	171°
8.39	8.32	7.99	7.42	6.64	5.71	4.71	3.64	2.57	1.54	0.89	0.78	0.71	0.66	0.56	0.44	0.34	0.25	0.18	0.16
100%	99%	95%	88%	79%	68%	56%	43%	31%	18%	11%	9%	8%	8%	7%	5%	4%	3%	2%	2%

Intensities in 90° c-plane

0°	9°	18°	27°	36°	45°	54°	63°	72°	81°	90°	99°	108°	117°	126°	135°	144°	153°	162°	171°
8.39	8.32	7.99	7.42	6.64	5.71	4.71	3.64	2.57	1.54	0.89	0.78	0.71	0.66	0.56	0.44	0.34	0.25	0.18	0.16
100%	99%	95%	88%	79%	68%	56%	43%	31%	18%	11%	9%	8%	8%	7%	5%	4%	3%	2%	2%

Intensities in 180° c-plane

0°	9°	18°	27°	36°	45°	54°	63°	72°	81°	90°	99°	108°	117°	126°	135°	144°	153°	162°	171°
8.39	8.29	7.94	7.36	6.60	5.70	4.69	3.64	2.58	1.58	0.84	0.62	0.56	0.50	0.43	0.38	0.32	0.29	0.23	0.20
100%	99%	95%	88%	79%	68%	56%	43%	31%	19%	10%	7%	7%	6%	5%	4%	4%	3%	3%	2%

Intensities in 270° c-plane

0°	9°	18°	27°	36°	45°	54°	63°	72°	81°	90°	99°	108°	117°	126°	135°	144°	153°	162°	171°
8.39	8.29	7.94	7.36	6.60	5.70	4.69	3.64	2.58	1.58	0.84	0.62	0.56	0.50	0.43	0.38	0.32	0.29	0.23	0.20
100%	99%	95%	88%	79%	68%	56%	43%	31%	19%	10%	7%	7%	6%	5%	4%	4%	3%	3%	2%

Beam angle 50%	Field angle 10%	Cutoff angle 2,5%	Intensity ratio in 120° cone	Intensity ratio in 90° cone
116.4°	183.7°	327.2°	65.1%	43.8%