

PrimaLine® 6.6 Gen 2 LED Tape Light

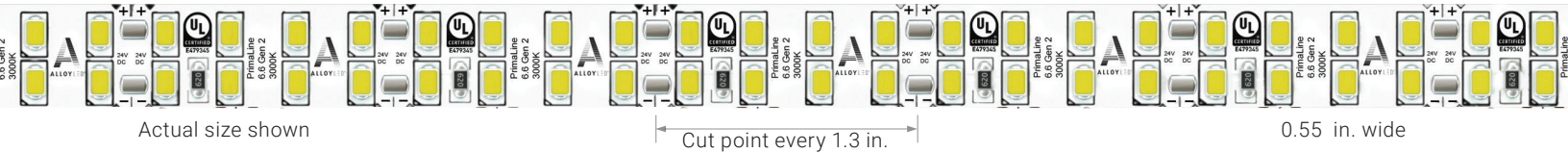

The PrimaLine Gen 2 family represents the next generation of LED lighting. Using the new, high-efficiency 2835 diode package, PrimaLine 6.6 Gen 2 offers super high output light at up to 835 lumens per foot, making it ideal for primary and large application accent lighting. PrimaLine 6.6 has a narrow form factor and its two rows of diodes makes installation quick and simple. Its evenly spaced dense diode placement minimizes hotspots to provide a smooth, even line of light.

- Next generation 2835 chips provide efficient lighting
- Up to 127 lumens per watt
- Two rows of powerful diodes for ultra high output primary source lighting
- Industry-leading 95+ CRI (Color Rendering Index)
- High R9 and R13 values for superb rendering of warm tones

TECHNICAL INFORMATION

Stocked CCTs (Color Temperature)*	2700K, 3000K, 4200K, 5000K*	Mounting	3M™ Self-Adhesive Tape (Non-porous)
Power Consumption Per Foot	6.6 Watts/275mA	Operating Temperature	-13° F to 140° F
Input Voltage	24V DC	Ambient Temperature	-40° F to 186° F
Diodes per foot	72	Environment	Indoor, Dry
Diode Spacing	0.33 inches	Spool Lengths	8 ft.**, 20 ft.***
Tape Height	0.07 inches	Certifications	UL Listed, UL 2108, CE, RoHS, UL Closet Rated
Beam Angle	120°	Standards	Certified to the CA Energy Commission in accordance with the Title 24 JA8 2016 std.
Field Cuttable (UL 2108)	Every 1.3 inches	Warranty	6 Year Limited
Max Run Length	20 ft.		
Dimmable	Yes		
Diode Type	2835 SMD		

* In addition to stocked colors, a wide variety of Color Temperatures is also available by special order. Please call or email to order.

**Each 8 ft. spool includes 8 ft., 20 AWG tinned lead wire at each end.

***Each 20 ft. spool includes 3 ft., 20 AWG tinned lead wire at each end.

PRODUCT INFORMATION

8 ft. spool Item Number	20 ft. spool Item Number	Voltage	Color Temperature	CRI	R9 Values	R13 Values	TM30	CQS	Lumens / foot
AL-01-18-2401	AL-01-18-2411	24V DC	● 2700K	97.2	94.5	97.8	92.6	94.2	656
AL-01-18-2402	AL-01-18-2412	24V DC	● 3000K	96.1	98	95.6	92.9	95.8	631
AL-01-18-2403	AL-01-18-2413	24V DC	○ 4200K	97.1	91.2	99	91.3	94.9	806
AL-01-18-2404	AL-01-18-2414	24V DC	● 5000K	93.1	75.4	95	87	90.4	835

VOLTAGE DROP GUIDANCE CHART

Standard Non-XT 24V Voltage Drop and Wire Length Distance Chart (3% Drop or 24V)

Wire Gauge	Copper Wire Resistance (Ω/kFT)	10W (0.42A)	20W (0.83A)	30W (1.25A)	40W (1.67A)	50W (2.08A)	60W (2.50A)	70W (2.92A)	80W (3.33A)	90W (3.75A)	96W (4A)
22 AWG	16.14	54 ft.	27 ft.	18 ft.	14 ft.	11 ft.	9 ft.	8 ft.	7 ft.	6 ft.	6 ft.
20 AWG	10.15	86 ft.	43 ft.	29 ft.	22 ft.	18 ft.	15 ft.	13 ft.	11 ft.	10 ft.	9 ft.
18 AWG	6.39	136 ft.	68 ft.	46 ft.	34 ft.	28 ft.	23 ft.	20 ft.	17 ft.	16 ft.	15 ft.
16 AWG	4.02	216 ft.	108 ft.	72 ft.	54 ft.	44 ft.	36 ft.	31 ft.	27 ft.	24 ft.	23 ft.
14 AWG	2.53	343 ft.	172 ft.	115 ft.	86 ft.	69 ft.	58 ft.	49 ft.	43 ft.	39 ft.	36 ft.
12 AWG	1.59	545 ft.	273 ft.	182 ft.	137 ft.	109 ft.	91 ft.	78 ft.	69 ft.	61 ft.	57 ft.
10 AWG	0.99	865 ft.	433 ft.	289 ft.	217 ft.	173 ft.	145 ft.	124 ft.	109 ft.	97 ft.	91 ft.

Note: These tables provide general guidelines for determining Wire Gauge based on total load and distance from LED driver to beginning of luminaire.

ACCESSORIES (SOLD SEPARATELY)

In-Wall-Rated Tape Light Connectors (20 AWG)

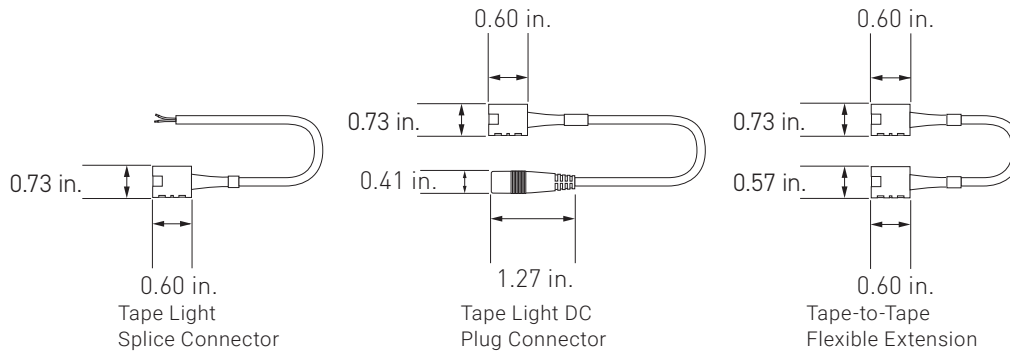

Item Number	Description	Wire Length
AL-01-18-9902	Tape Light Splice Connector	6 in.
AL-01-18-9907	Tape Light Splice Connector	36 in.
AL-01-18-9910	Tape Light Splice Connector	8 ft.

Item Number	Description	Wire Length
AL-01-18-9912	Tape-to-Tape Flexible Extension	6 in.
AL-01-18-9917	Tape-to-Tape Flexible Extension	36 in.
AL-01-18-9922	Tape Light DC Plug Connector	6 in.
AL-01-18-9927	Tape Light DC Plug Connector	36 in.

AmpChamp: For a more secure connection

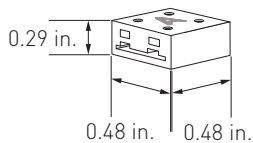

Accepts many combinations of tape and wire. Includes spade connectors for stranded wire, 3M[®] adhesive backing, and pre-attached 6 inch in-wall-rated 18 AWG lead wire.

Note: AmpChamp Corner does not include the pre-attached 6 inch in-wall-rated 18 AWG lead wire.

Straight AmpChamp

- AL-01-18-9900
- AL-01-18-9900-10 (10-pack)
- AL-01-18-9900-100 (100-pack)

AmpChamp Jumper and Power Feed Kits

AmpChamp Jumper Kit includes two standard AmpChamp Kits and one pre-tinned 18 AWG jumper wire.



- AL-01-18-9900-3IN-JK (3 in. jumper wire)
- AL-01-18-9900-6IN-JK (6 in. jumper wire)
- AL-01-18-9900-36IN-JK (36 in. jumper wire)

AmpChamp Power Feed Kit includes one standard AmpChamp Kit and one pre-tinned 18 AWG power feed wire.



- AL-01-18-9900-36IN-PK (36 in. power feed wire)
- AL-01-18-9900-8FT-PK (8 ft. power feed wire)

Wire and Tape Light Management

We recommend the use of the wire and tape harness.

- At least 1 wire harness at the beginning to secure the lead wire; for longer lead wires, place a harness every 2 feet
- 1 tape harness every 2 feet and 1 harness at the end of the tape light to secure it

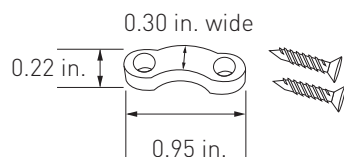

Wire Harness

Holds wire in place securely
AL-01-99-9901-10 (10-pack)

ALLOY LED[®] Specifications

COMPATIBLE CHANNELS (Diagrams below not to scale)

Reduced Hotspot Pairings (Hotspot Rating from 0-5)

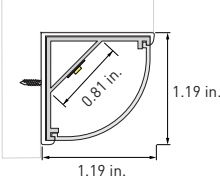
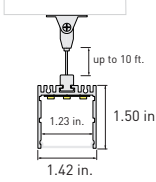
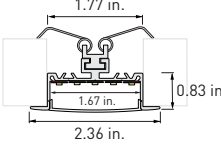
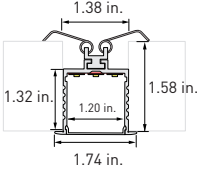
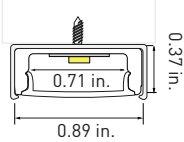
<p>Surfa 2X: Corner-Mount</p>  <p>Hotspot Rating: 0</p> <ul style="list-style-type: none"> <input checked="" type="checkbox"/> Solder <input checked="" type="checkbox"/> Connector <input checked="" type="checkbox"/> AmpChamp 	<p>Suspan 1: Suspended</p>  <p>Hotspot Rating: 0</p> <ul style="list-style-type: none"> <input checked="" type="checkbox"/> Solder <input checked="" type="checkbox"/> Connector <input checked="" type="checkbox"/> AmpChamp 	<p>Ankr 1: In-Wall</p>  <p>Hotspot Rating: 0</p> <ul style="list-style-type: none"> <input checked="" type="checkbox"/> Solder <input checked="" type="checkbox"/> Connector <input checked="" type="checkbox"/> AmpChamp
<p>Ankr 2: In-Wall</p>  <p>Hotspot Rating: 0</p> <ul style="list-style-type: none"> <input checked="" type="checkbox"/> Solder <input checked="" type="checkbox"/> Connector <input checked="" type="checkbox"/> AmpChamp 	<p>Polymer: Surface-Mount</p>  <p>Hotspot Rating: 1</p> <ul style="list-style-type: none"> <input checked="" type="checkbox"/> Solder <input type="checkbox"/> Connector <input type="checkbox"/> AmpChamp 	

ALLOY LED[®] Specifications

COMPATIBLE CHANNELS (Diagrams below not to scale)

Other Compatible Pairings (Hotspot Rating from 0-5)

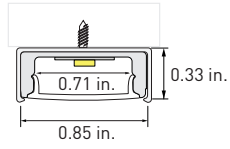
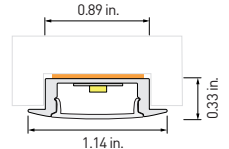
<p>Surfa 6: Surface-Mount</p>  <p>Hotspot Rating: 5</p> <ul style="list-style-type: none"><input checked="" type="checkbox"/> Solder<input type="checkbox"/> Connector<input type="checkbox"/> AmpChamp	<p>Naro 4: Recessed</p>  <p>Hotspot Rating: 5</p> <ul style="list-style-type: none"><input checked="" type="checkbox"/> Solder<input type="checkbox"/> Connector<input type="checkbox"/> AmpChamp
---	---

ALLOY LED[®] Specifications

RECOMMENDED POWER SUPPLIES (SOLD SEPARATELY)



Alloy LED PowerFactor™ Dimmable Power Supplies with Integrated UL Listed Junction Box
Compact, highly efficient, and code-compliant power supply with versatile and smooth dimming capabilities.

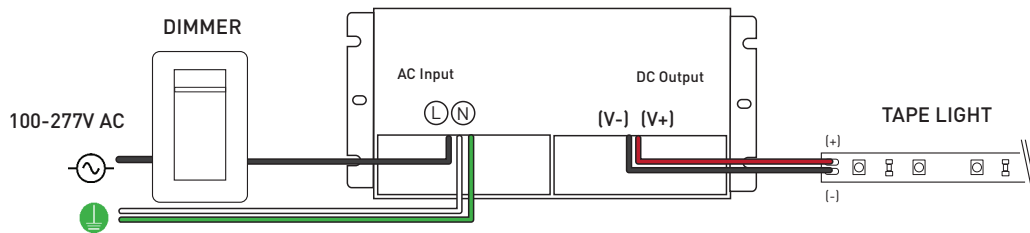

Wiring diagram is for reference only. Please refer to dimmer wiring specifications sheet for accurate directions.

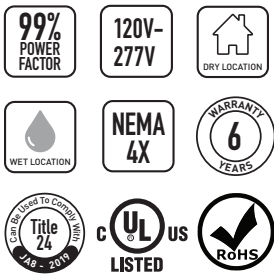

Single Tap Models

Item Number	Output Voltage	Wattage	Wet Location	Minimum Load	Dimensions (L x W x H)	Class 2
AL-98-10-12030	12V DC	30W	Yes (NEMA 4X)	10%	6.50 x 3.72 x 1.02 in.	Yes
AL-98-10-12060	12V DC	60W	Yes (NEMA 4X)	10%	7.40 x 3.72 x 1.02 in.	Yes
AL-98-10-12120	12V DC	120W	Yes (NEMA 4X)	10%	8.66 x 3.72 x 1.57 in.	No
AL-98-10-24030	24V DC	30W	Yes (NEMA 4X)	10%	6.50 x 3.72 x 1.02 in.	Yes
AL-98-10-24060	24V DC	60W	Yes (NEMA 4X)	10%	7.40 x 3.72 x 1.02 in.	Yes
AL-98-10-24096	24V DC	96W	Yes (NEMA 4X)	10%	8.66 x 3.72 x 1.57 in.	Yes
AL-98-10-24150	24V DC	150W	Yes (NEMA 4X)	10%	10.24 x 4.13 x 1.77 in.	No
AL-98-10-24200	24V DC	200W	Yes (NEMA 4X)	10%	10.24 x 4.13 x 1.77 in.	No
AL-98-10-24300	24V DC	300W	Yes (NEMA 4X)	10%	10.94 x 4.33 x 1.77 in.	No

Class 2 Compliant Multi-Tap Models

Item Number	Output Voltage	Wattage	Wet Location	Minimum Load	Dimensions (L x W x H)	Class 2
AL-98-10-12300-MT	12V DC	300W	Yes (NEMA 4X)	10%	11.85 x 4.33 x 1.77 in.	Yes
AL-98-10-24192-MT	24V DC	192W	Yes (NEMA 4X)	10%	10.94 x 4.33 x 1.77 in.	Yes
AL-98-10-24288-MT	24V DC	288W	Yes (NEMA 4X)	10%	11.85 x 4.33 x 1.77 in.	Yes

Note: PowerFactor assumes 80% load.
Inspectors prefer power supply to be used with junction box.
For dimmer compatibility, refer to drivers specification sheet.

ALLOY LED[®] Specifications

RECOMMENDED POWER SUPPLIES (SOLD SEPARATELY)

Alloy LED Primavolt[®] No Minimum Load Dimmable Power Supplies with ETL Listed Junction Box
Code-compliant power supply with versatile and smooth dimming capabilities. Compatible with Incandescent, On/Off, ELV and MLV dimmers.

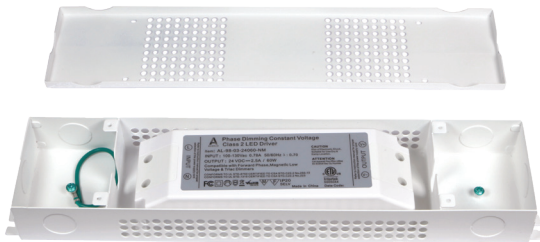

Dry Location Model
White model for 60W and lower



Wet Location Model
Black model for 80W and higher

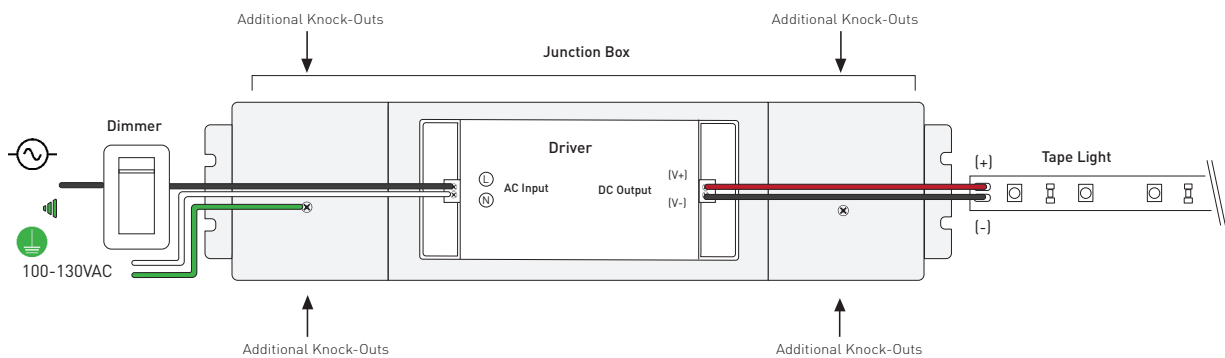

Wiring diagram is for reference only. Please refer to dimmer wiring specifications sheet for accurate directions.

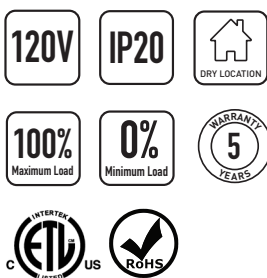

Item Number	Output Voltage	Wattage	Minimum Load	Dimensions (Junction Box) (L x W x H)	Class 2
AL-98-03-12024-NM	12V DC	24W	0%	13.78 x 3.03 x 1.46 in.	Yes
AL-98-03-12048-NM	12V DC	48W	0%	13.78 x 3.03 x 1.46 in.	Yes
AL-98-03-12060-NM	12V DC	60W	0%	13.78 x 3.03 x 1.46 in.	Yes
AL-98-03-12080-NM	12V DC	80W	0%	14.96 x 3.03 x 2.24 in.	No
AL-98-03-12120-NM	12V DC	120W	0%	14.96 x 3.03 x 2.24 in.	No
AL-98-03-24024-NM	24V DC	24W	0%	13.78 x 3.03 x 1.46 in.	Yes
AL-98-03-24048-NM	24V DC	48W	0%	13.78 x 3.03 x 1.46 in.	Yes
AL-98-03-24060-NM	24V DC	60W	0%	13.78 x 3.03 x 1.46 in.	Yes
AL-98-03-24080-NM	24V DC	80W	0%	14.96 x 3.03 x 2.24 in.	Yes
AL-98-03-24096-NM	24V DC	96W	0%	14.96 x 3.03 x 2.24 in.	Yes
AL-98-03-24150-NM	24V DC	150W	0%	15.98 x 3.43 x 2.36 in.	No
AL-98-03-24200-NM	24V DC	200W	0%	15.98 x 3.43 x 2.36 in.	No

Note: Alloy LED strongly recommends using Listed Class 2 power supplies for all installations. Always install in accordance with local and national electrical code regulations. Inspectors prefer power supply to be used with junction box. For dimmer compatibility, refer to drivers specification sheet.

ALLOY LED[®] Specifications

RECOMMENDED POWER SUPPLIES (SOLD SEPARATELY)

ELV Dimmable Power Supplies for Remote Enclosures

The drivers are derated, but when installed in a small enclosure with no heatsink or air circulation, we recommend a maximum load of 40W.

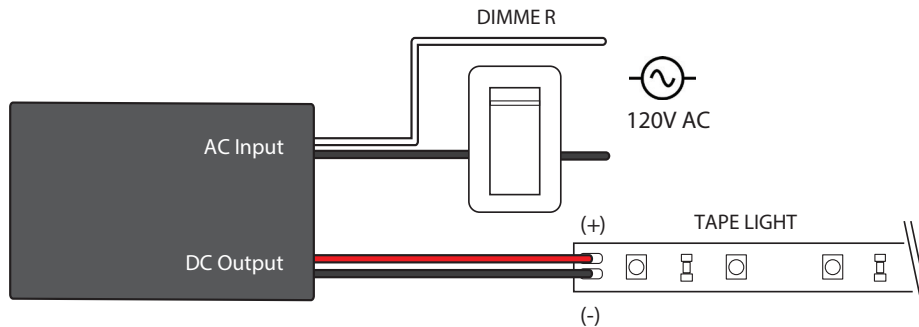

Wiring diagram is for reference only. Please refer to dimmer wiring specifications sheet for accurate directions.

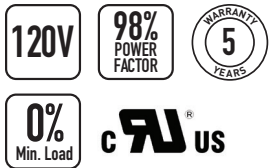

Item Number	Output	Wattage	Dimensions (L x W x H)	Class 2
AL-98-08-12060	12V DC	60W	2.66 x 1.30 x 0.83 in.	Yes
AL-98-08-24060	24V DC	60W	2.66 x 1.30 x 0.83 in.	Yes

Note: Inspectors prefer power supply to be used with junction box.
For dimmer compatibility, refer to drivers specification sheet.

ALLOY LED[®] Specifications

DIMMING ACCESSORIES (SOLD SEPARATELY)

Lutron[®] Dimming Accessories

By participating in Lutron's OEM Advantage program, Alloy LED is able to offer a range of the highest quality low voltage power supplies and selected controls on the market.



Hi-lume Premier
0.1% EcoSystem /
3-wire LED Driver
(96W 24VDC)



Hi-lume 1% LED Driver 40W
- EcoSystem / 3-wire control
- 2-wire 120V forward
phase control



Lutron Vive PowPak RF Module
- RF module for EcoSystem LED
driver control
- Use with the Lutron EcoSystem
drivers shown to "Vive-enable"
Alloy LED products

Lutron[®] Hi-lume LED Drivers

Item Number	Output	Wattage	Minimum Load	Class 2
AL-98-07-12040	12V DC	40W	N/A	Yes
AL-98-07-12040-3WIRE	12V DC	40W	N/A	Yes
AL-98-07-24040	24V DC	40W	N/A	Yes
AL-98-07-24040-3WIRE	24V DC	40W	N/A	Yes
AL-98-07-24096-3WIRE	24V DC	96W	N/A	Yes

Lutron[®] Controls

Item Number	Description	Voltage
AL-98-07-9901	EcoSystem Control Module	N/A
AL-98-07-9901-8	EcoSystem Control Module - 8-pack	N/A
AL-98-07-9950	CL Dimmer	120V AC
AL-98-07-9950-FPLATE	CL Dimmer faceplate	N/A

DIMMING ACCESSORIES (SOLD SEPARATELY)

Dimmers and Switches

SlimDim Wireless Dimmer Switch

Using long-range RF technology, these LED dimmers connect wirelessly to a receiver, offering freedom to mount anywhere. Can also be used as a fob for mobile, hand-held control.

AL-70-01-0001	SlimDim Wireless Dimmer
AL-70-01-0002	Single Color Receiver (96W max.) (sold separately)
AL-98-07-9950 -FPLATE	SlimDim Wall Plate (sold separately)

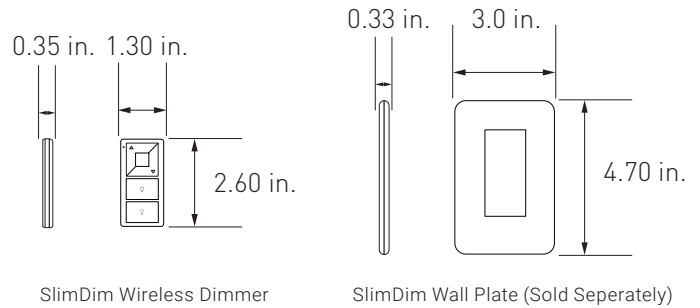

Remote Control Dimmer Switch

Provides full dimming and on/off control, and includes a touch wheel that allows for direct visual selection of brightness. It can also operate up to four independent zones.

AL-60-03-0001	Remote Control Dimmer Switch
AL-70-01-0002	Single Channel Receiver (sold separately)
AL-60-03-0004-V2	Wireless Receiver (RGB & RGBW) (sold separately)

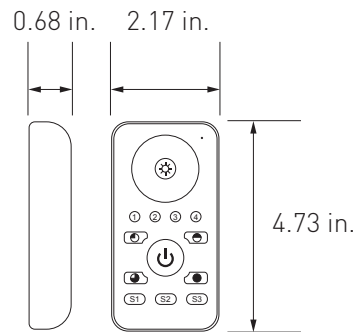

Single Channel Wireless Receiver

Pair with the Remote Control Dimmer Switch or the SlimDim Wireless Dimmer to dim PrimaLine tape lights. Use one remote to make independent lighting zones with multiple receivers with certain controllers.

AL-70-01-0002	Single Channel Wireless Receiver
---------------	----------------------------------

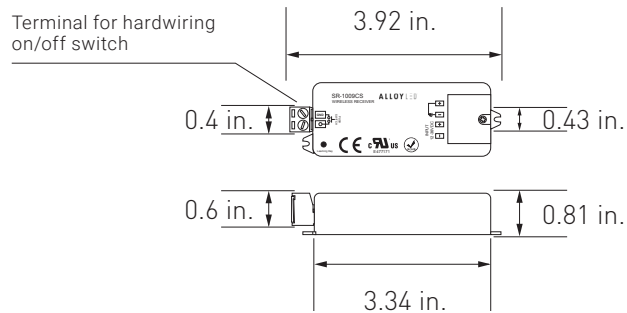

WIRING DIAGRAM

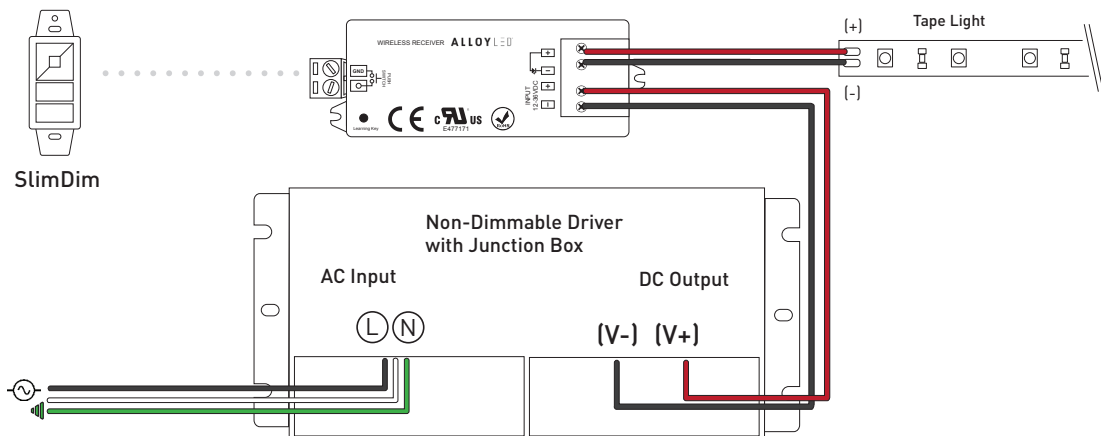

ALLOY LED[®] Specifications

RECOMMENDED POWER SUPPLIES (SOLD SEPARATELY)

Alloy LED TRIAC/MLV/ELV Dimmable Drivers for Remote Locations

Offers stable power in even in the most remote settings. Compatibility with TRIAC, ELV, or MLV dimmers.

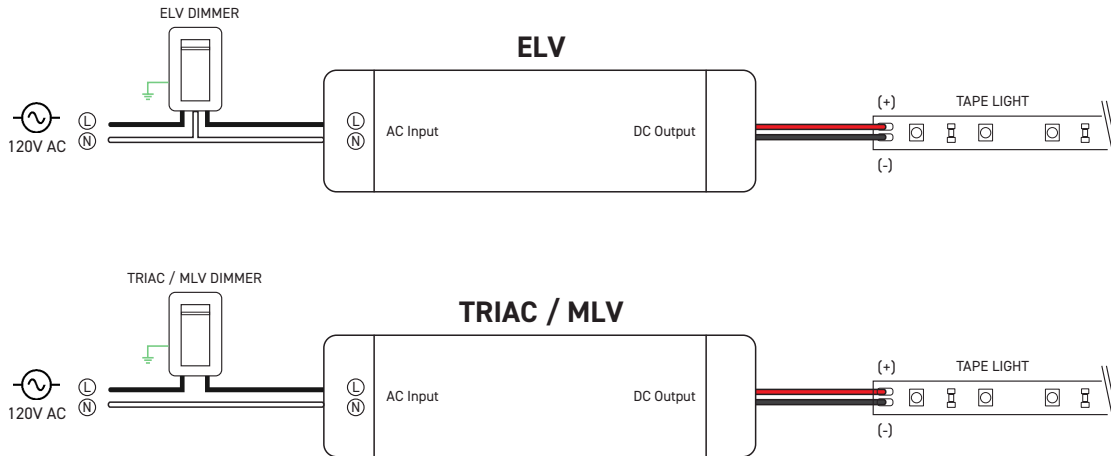

Wiring diagram is for reference only. Please refer to dimmer wiring specifications sheet for accurate directions.

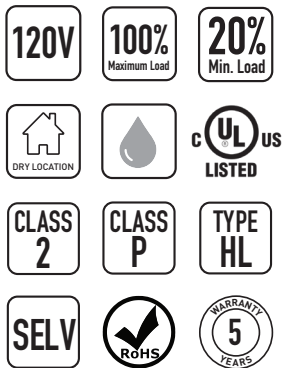

Item Number	Output Voltage	Wattage	Dimensions (L x W x H)	Class 2
AL-98-09-12060	12V DC	60W	3.31 x 1.57 x 0.98	Yes
AL-98-09-24096	24V DC	96W	3.31 x 1.57 x 0.98	Yes

Note: Alloy LED strongly recommends using Listed Class 2 power supplies for all installations. Always install in accordance with local and national electrical code regulations. Inspectors prefer power supply to be used with junction box. For dimmer compatibility, refer to drivers specification sheet.

Note: specifications are representative of the diode type and not a particular tape light article.

2700K

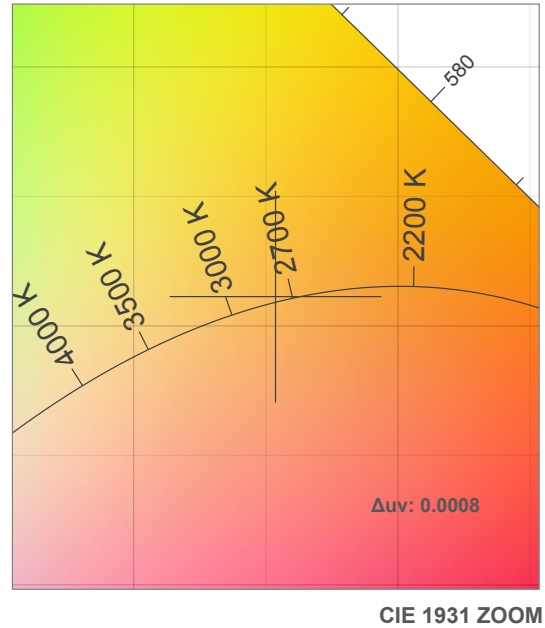
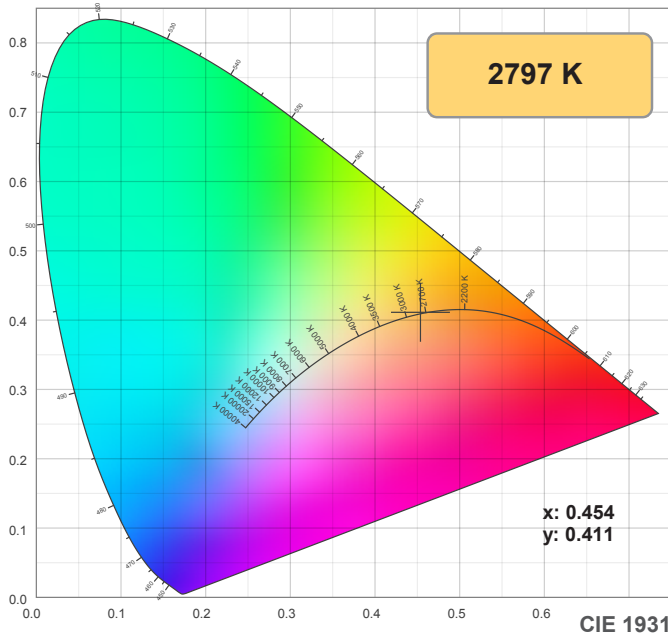

TM30: 92.6

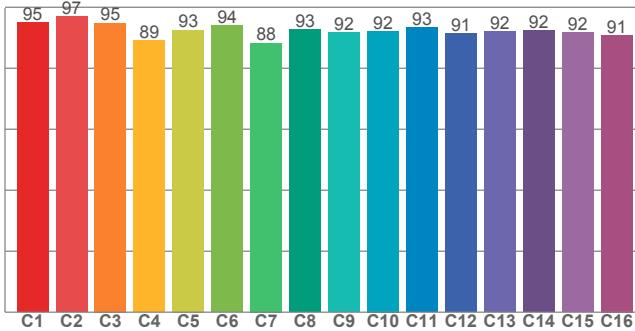

CRI: 97.2 (R1-R8)

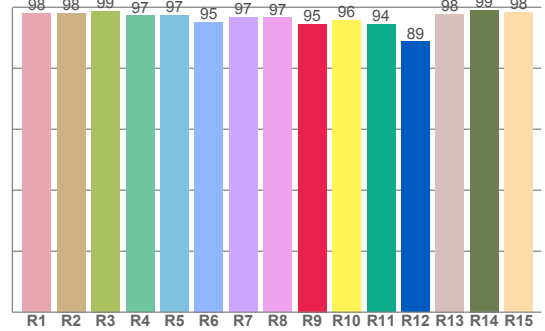

CRI R values, only R1-R8 are used to calculate final CRI value

R1	R2	R3	R4	R5	R6	R7	R8	R9	R10	R11	R12	R13	R14	R15
98.0	98.1	98.7	97.2	97.3	95.2	96.7	96.6	94.5	95.9	94.4	88.7	97.8	99.1	98.3

TM30 C values, 16 binned values out of total of 99 C values

C1	C2	C3	C4	C5	C6	C7	C8	C9	C10	C11	C12	C13	C14	C15	C16
94.9	97.0	94.9	89.1	92.6	94.0	88.3	92.8	91.7	92.2	93.4	91.3	92.1	92.3	91.7	90.8

CQS Q values

Q1	Q2	Q3	Q4	Q5	Q6	Q7	Q8	Q9	Q10	Q11	Q12	Q13	Q14	Q15
90.8	94.1	97.4	97.3	96.7	95.3	94.6	94.1	92.6	91.6	94.1	95.1	96.6	96.2	93.9

CQS: 94.2

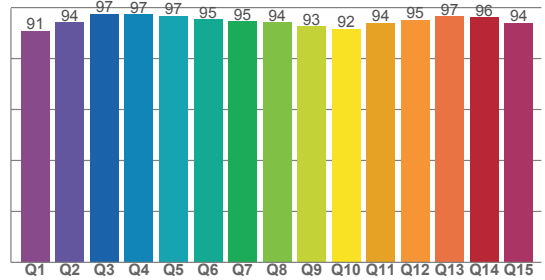

Color parameters

Color temperature	Color rendering index	Red component	Color fidelity	Color gamut	Color quality scale	Color coordinate cie 1931	Color coordinate cie 1931	Color coordinate	Color coordinate	Color division from black body
CCT	CRI	CRI R9	TM30 Rf	TM30 Rg	CQS	x	y	u	v	Δuv
2797 K	97.2	94.5	92.6	98.3	94.2	0.454	0.411	0.258	0.351	0.0008

Note: specifications are representative of the diode type and not a particular tape light article.

2700K

Rf 92.6
Fidelity index Rf

Rg 98.3
Gammut index Rg

Hue Bin	R _f	Graphic shifts (%)	
		Chroma	Hue
1	95	-1%	1%
2	97	0%	-1%
3	95	-1%	-2%
4	89	-5%	-5%
5	93	-6%	-1%
6	94	-3%	2%
7	88	-4%	5%
8	93	1%	4%
9	92	1%	5%
10	92	3%	4%
11	93	4%	2%
12	91	3%	-3%
13	92	-1%	-5%
14	92	1%	-5%
15	92	-3%	1%
16	91	0%	-6%

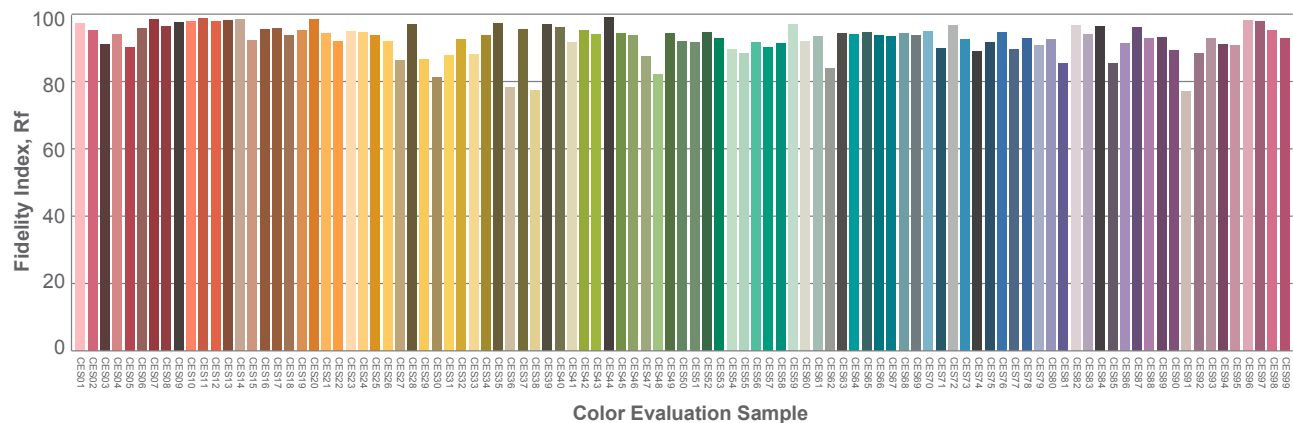
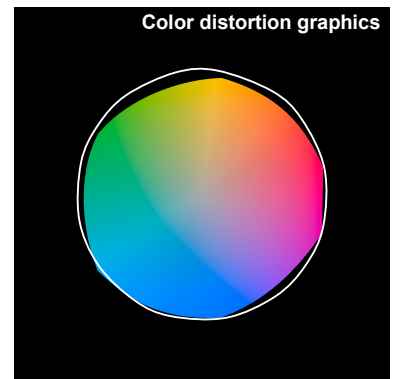
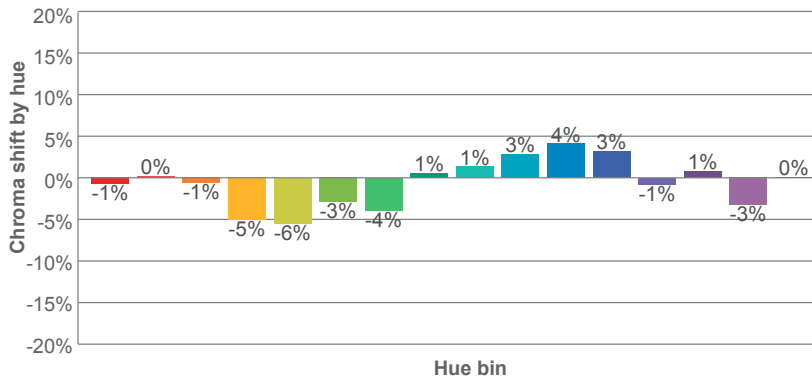
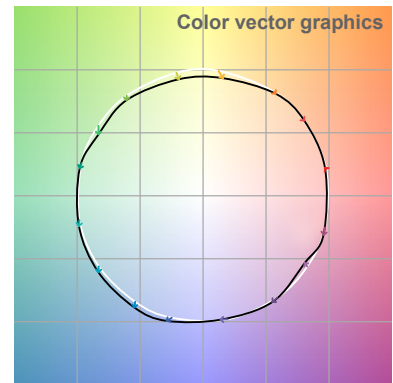
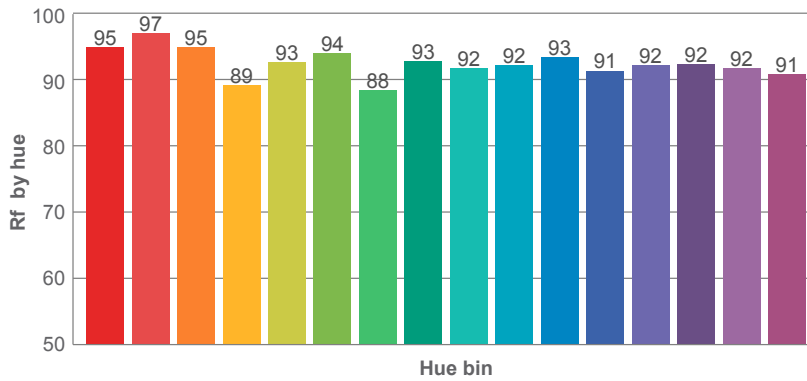
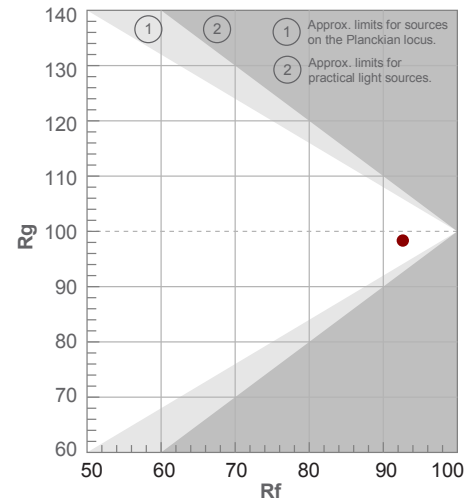

Note: specifications are representative of the diode type and not a particular tape light article.

2700K

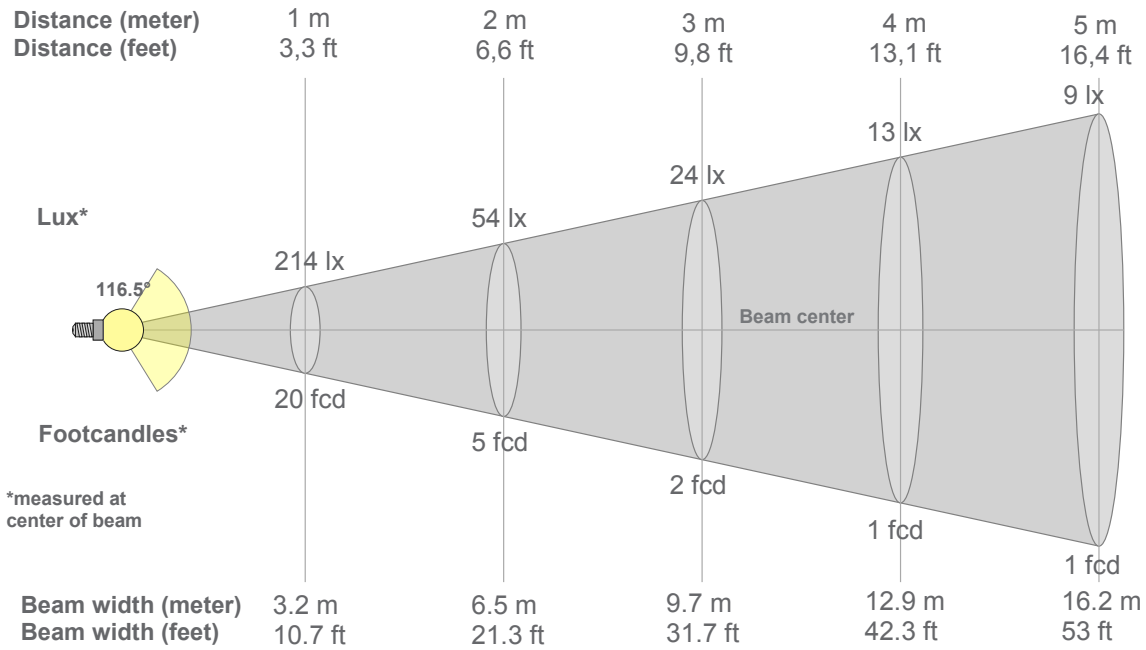

Beam intensities from 1-20m

1m	2m	3m	4m	5m	6m	7m	8m	9m	10m	11m	12m	13m	14m	15m	16m	17m	18m	19m	20m
3.3ft	6.6ft	9.8ft	13.1ft	16.4ft	19.7ft	23ft	26.2ft	29.5ft	32.8ft	36.1ft	39.4ft	42.7ft	45.9ft	49.2ft	52.5ft	55.8ft	59.1ft	62.3ft	65.6ft
214lx	54lx	24lx	13lx	9lx	6lx	4lx	3lx	3lx	2lx	2lx	1lx	1lx	1lx	1lx	1lx	1lx	1lx	1lx	1lx
19.9fcd	5fcd	2.2fcd	1.2fcd	0.8fcd	0.6fcd	0.4fcd	0.3fcd	0.2fcd	0.2fcd	0.2fcd	0.1fcd	0.1fcd	0.1fcd	0.1fcd	0.1fcd	0.1fcd	0.1fcd	0.1fcd	0fcd

Intensities in 0° c-plane

0°	5°	10°	15°	20°	25°	30°	35°	40°	45°	50°	55°	60°	65°	70°	75°	80°	85°	90°	95°
214	213	210	205	199	191	182	171	159	146	132	117	102	85	67	49	31	15	4	1
100%	99%	98%	96%	93%	89%	85%	80%	74%	68%	62%	55%	47%	40%	31%	23%	15%	7%	2%	1%

Intensities in 90° c-plane

0°	5°	10°	15°	20°	25°	30°	35°	40°	45°	50°	55°	60°	65°	70°	75°	80°	85°	90°	95°
214	213	210	205	199	191	182	171	159	146	132	117	102	85	67	49	31	15	4	1
100%	99%	98%	96%	93%	89%	85%	80%	74%	68%	62%	55%	47%	40%	31%	23%	15%	7%	2%	1%

Intensities in 180° c-plane

0°	5°	10°	15°	20°	25°	30°	35°	40°	45°	50°	55°	60°	65°	70°	75°	80°	85°	90°	95°
214	214	211	207	200	192	183	172	160	146	132	117	101	84	67	50	33	17	4	1
100%	100%	99%	96%	94%	90%	85%	80%	75%	68%	62%	55%	47%	39%	31%	23%	15%	8%	2%	0%

Intensities in 270° c-plane

0°	5°	10°	15°	20°	25°	30°	35°	40°	45°	50°	55°	60°	65°	70°	75°	80°	85°	90°	95°
214	214	211	207	200	192	183	172	160	146	132	117	101	84	67	50	33	17	4	1
100%	100%	99%	96%	94%	90%	85%	80%	75%	68%	62%	55%	47%	39%	31%	23%	15%	8%	2%	0%

Beam angle 50%	Field angle 10%	Cutoff angle 2,5%	Intensity ratio in 120° cone	Intensity ratio in 90° cone
116.5°	166.3°	178.4°	74.9%	50.4%

Note: specifications are representative of the diode type and not a particular tape light article.

3000K

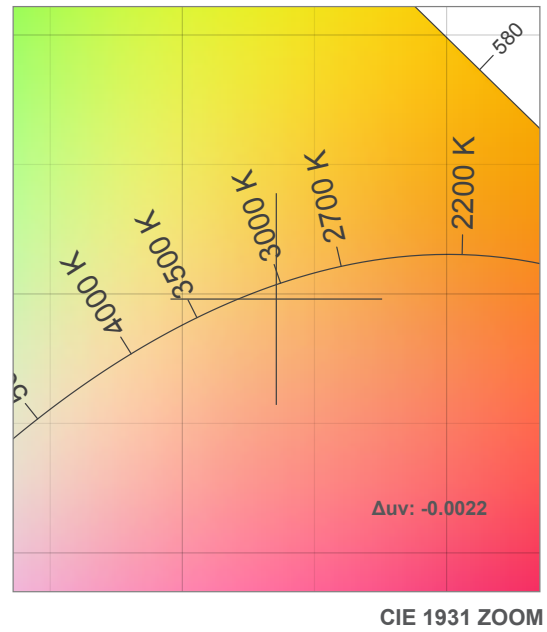
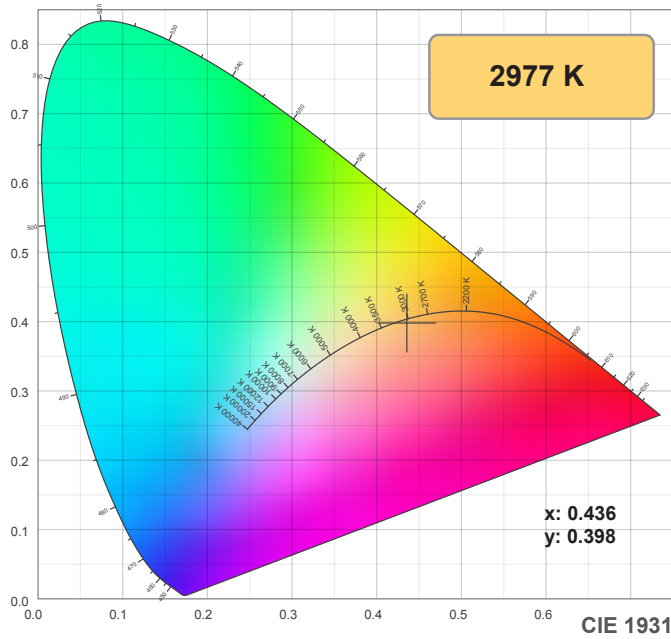

TM30: 92.9

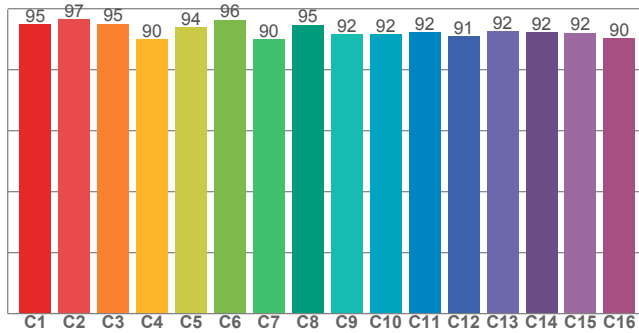

CRI: 96.1 (R1-R8)

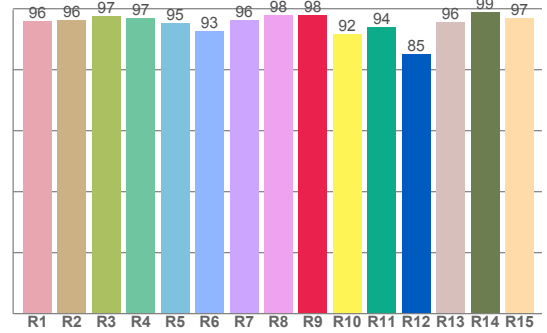

CRI R values, only R1-R8 are used to calculate final CRI value

R1	R2	R3	R4	R5	R6	R7	R8	R9	R10	R11	R12	R13	R14	R15
96.0	96.1	97.5	97.0	95.3	92.6	96.4	97.8	98.0	91.7	93.8	85.0	95.6	99.0	97.0

TM30 C values, 16 binned values out of total of 99 C values

C1	C2	C3	C4	C5	C6	C7	C8	C9	C10	C11	C12	C13	C14	C15	C16
95.0	96.5	95.1	90.0	93.8	96.3	90.0	94.7	91.6	91.5	92.2	91.0	92.5	92.2	92.1	90.4

CQS Q values

Q1	Q2	Q3	Q4	Q5	Q6	Q7	Q8	Q9	Q10	Q11	Q12	Q13	Q14	Q15
92.1	95.7	96.7	96.7	96.7	96.8	97.8	97.9	96.8	96.4	96.6	97.5	97.9	95.2	94.2

CQS: 95.8

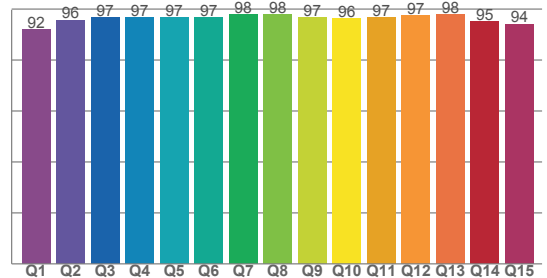

Color parameters

Color temperature	Color rendering index	Red component	Color fidelity	Color gamut	Color quality scale	Color coordinate cie 1931	Color coordinate cie 1931	Color coordinate	Color coordinate	Color deviation from black body
CCT	CRI	CRI R9	TM30 Rf	TM30 Rg	CQS	x	y	u	v	Δuv
2977 K	96.1	98.0	92.9	100.0	95.8	0.436	0.398	0.252	0.346	-0.0022

Note: specifications are representative of the diode type and not a particular tape light article.

3000K

Rf 92.9
Fidelity index Rf

Rg 100.0
Gammut index Rg

Hue Bin	R _f	Graphic shifts (%)	
		Chroma	Hue
1	95	0%	1%
2	97	1%	-1%
3	95	0%	-1%
4	90	-4%	-4%
5	94	-4%	-1%
6	96	-1%	1%
7	90	-3%	5%
8	95	1%	3%
9	92	2%	5%
10	92	3%	4%
11	92	5%	2%
12	91	4%	-3%
13	92	0%	-5%
14	92	2%	-5%
15	92	-3%	1%
16	90	1%	-7%

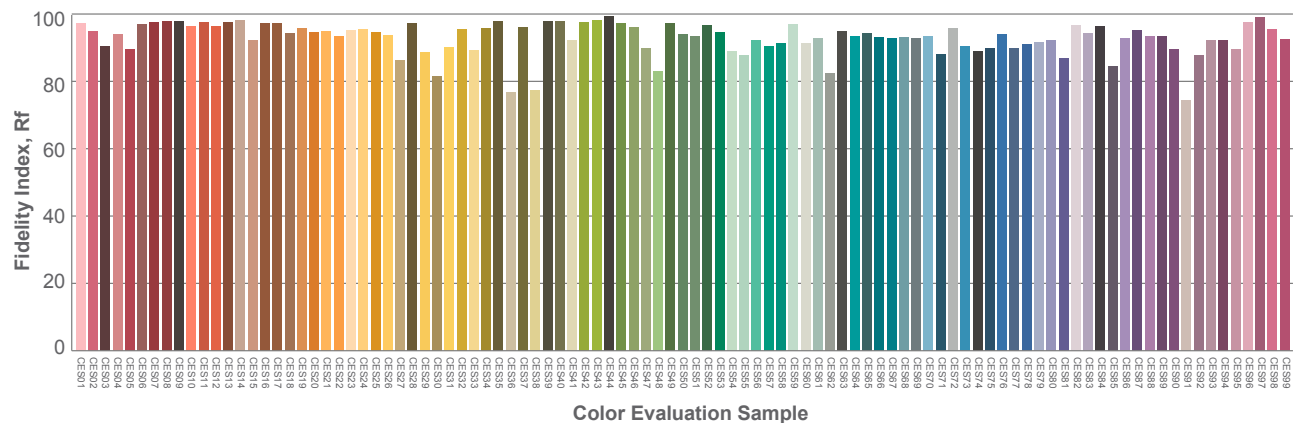
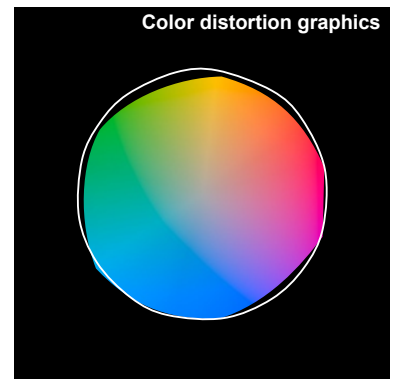
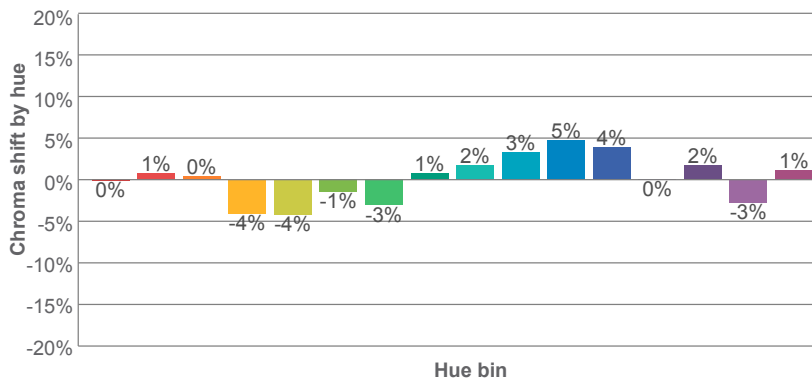
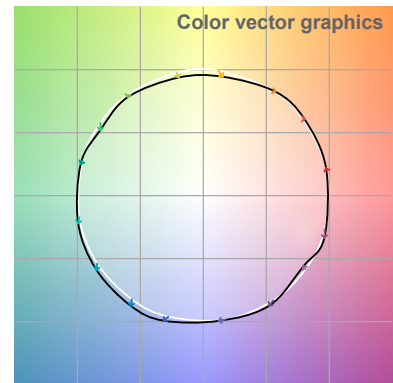
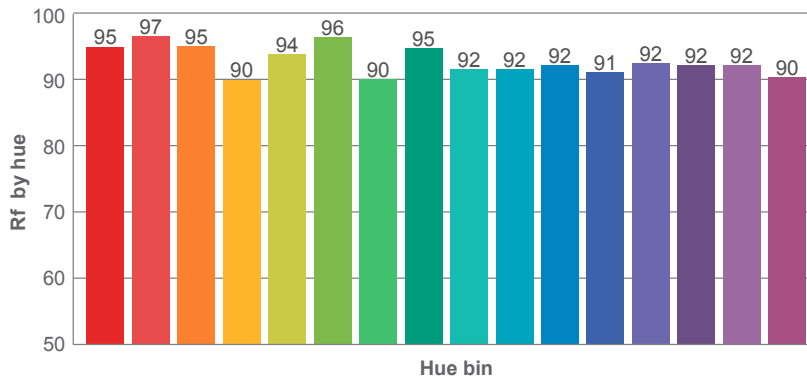
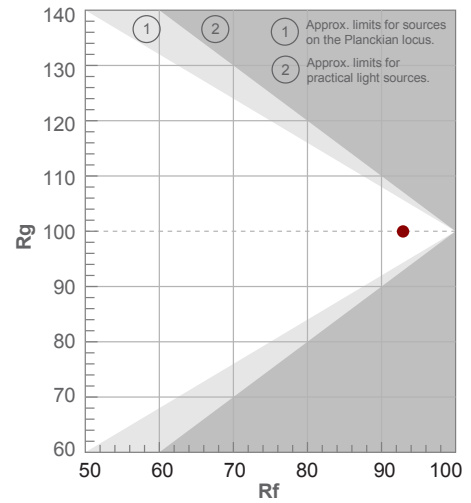

Note: specifications are representative of the diode type and not a particular tape light article.

3000K

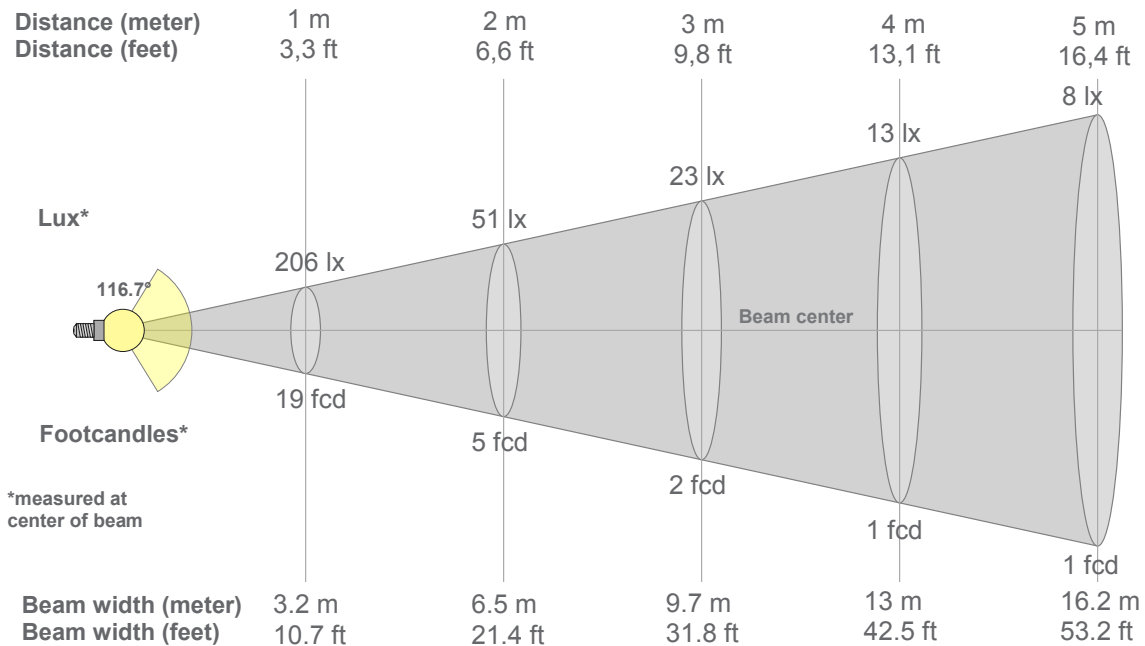

Beam intensities from 1-20m

1m	2m	3m	4m	5m	6m	7m	8m	9m	10m	11m	12m	13m	14m	15m	16m	17m	18m	19m	20m
3.3ft	6.6ft	9.8ft	13.1ft	16.4ft	19.7ft	23ft	26.2ft	29.5ft	32.8ft	36.1ft	39.4ft	42.7ft	45.9ft	49.2ft	52.5ft	55.8ft	59.1ft	62.3ft	65.6ft
206lx	51lx	23lx	13lx	8lx	6lx	4lx	3lx	3lx	2lx	2lx	1lx	1lx	1lx	1lx	1lx	1lx	1lx	1lx	1lx
19.1fcd	4.8fcd	2.1fcd	1.2fcd	0.8fcd	0.5fcd	0.4fcd	0.3fcd	0.2fcd	0.2fcd	0.2fcd	0.1fcd	0.1fcd	0.1fcd	0.1fcd	0.1fcd	0.1fcd	0.1fcd	0.1fcd	0fcd

Intensities in 0° c-plane

0°	5°	10°	15°	20°	25°	30°	35°	40°	45°	50°	55°	60°	65°	70°	75°	80°	85°	90°	95°
206	205	202	197	191	184	174	164	152	140	127	113	98	82	65	48	31	16	4	1
100%	100%	98%	96%	93%	89%	85%	80%	74%	68%	62%	55%	48%	40%	32%	23%	15%	8%	2%	0%

Intensities in 90° c-plane

0°	5°	10°	15°	20°	25°	30°	35°	40°	45°	50°	55°	60°	65°	70°	75°	80°	85°	90°	95°
206	205	202	197	191	184	174	164	152	140	127	113	98	82	65	48	31	16	4	1
100%	100%	98%	96%	93%	89%	85%	80%	74%	68%	62%	55%	48%	40%	32%	23%	15%	8%	2%	0%

Intensities in 180° c-plane

0°	5°	10°	15°	20°	25°	30°	35°	40°	45°	50°	55°	60°	65°	70°	75°	80°	85°	90°	95°
206	205	203	199	193	185	176	166	154	142	128	113	98	82	65	48	31	15	4	1
100%	100%	99%	97%	94%	90%	86%	81%	75%	69%	62%	55%	47%	40%	32%	23%	15%	7%	2%	0%

Intensities in 270° c-plane

0°	5°	10°	15°	20°	25°	30°	35°	40°	45°	50°	55°	60°	65°	70°	75°	80°	85°	90°	95°
206	205	203	199	193	185	176	166	154	142	128	113	98	82	65	48	31	15	4	1
100%	100%	99%	97%	94%	90%	86%	81%	75%	69%	62%	55%	47%	40%	32%	23%	15%	7%	2%	0%

Beam angle 50%	Field angle 10%	Cutoff angle 2,5%	Intensity ratio in 120° cone	Intensity ratio in 90° cone
116.7°	166.5°	178.7°	75.0%	50.4%

Note: specifications are representative of the diode type and not a particular tape light article.

4200K

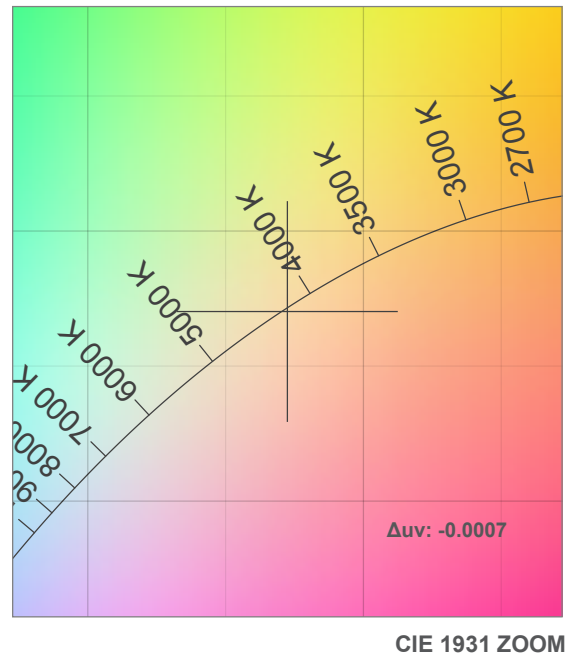
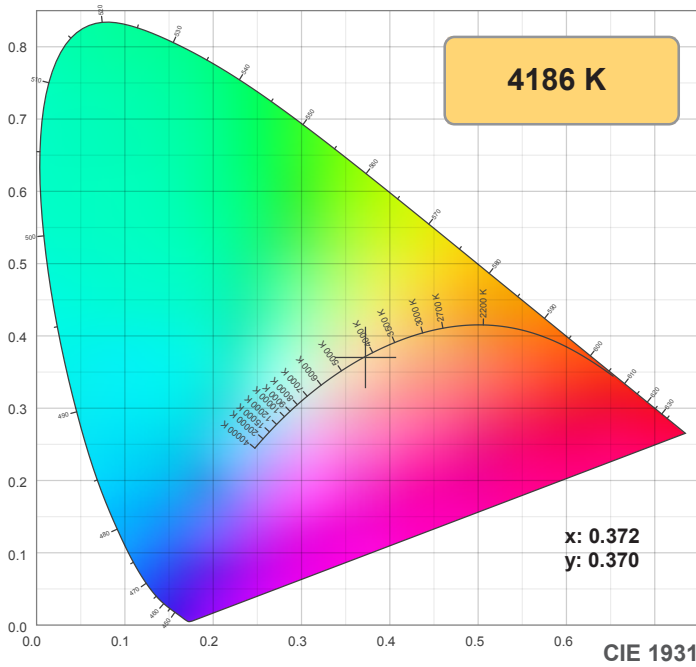

TM30: 91.3

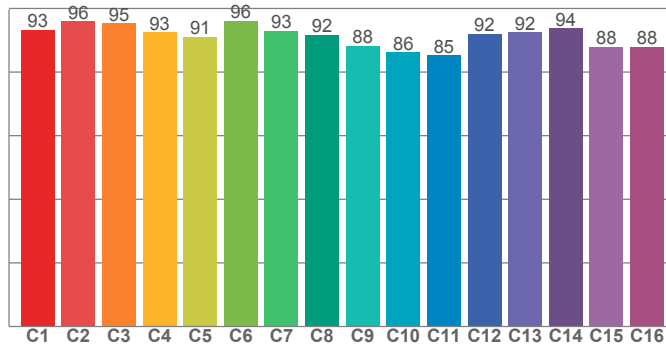

CRI: 97.1 (R1-R8)

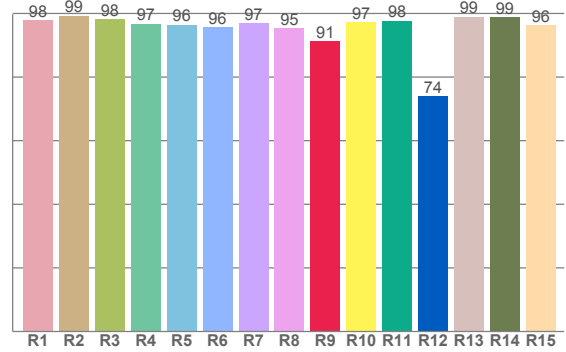

CRI R values, only R1-R8 are used to calculate final CRI value

R1	R2	R3	R4	R5	R6	R7	R8	R9	R10	R11	R12	R13	R14	R15
97.9	99.3	98.3	96.8	96.5	95.6	97.0	95.5	91.2	97.4	97.7	74.0	99.0	98.9	96.3

TM30 C values, 16 binned values out of total of 99 C values

C1	C2	C3	C4	C5	C6	C7	C8	C9	C10	C11	C12	C13	C14	C15	C16
93.3	95.9	95.4	92.6	91.1	96.2	92.9	91.7	88.3	86.2	85.2	92.0	92.5	93.7	88.0	88.0

CQS Q values

Q1	Q2	Q3	Q4	Q5	Q6	Q7	Q8	Q9	Q10	Q11	Q12	Q13	Q14	Q15
93.1	98.6	90.0	89.0	92.9	95.5	97.5	97.8	99.3	98.3	97.6	97.8	97.9	97.2	96.0

CQS: 94.9

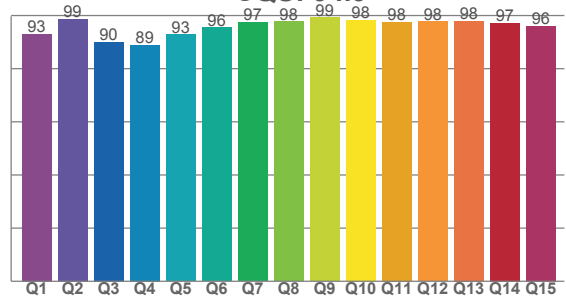

Color parameters

Color temperature	Color rendering index	Red component	Color fidelity	Color gamut	Color quality scale	Color coordinate cie 1931	Color coordinate cie 1931	Color coordinate	Color coordinate	Color deviation from black body
CCT	CRI	CRI R9	TM30 Rf	TM30 Rg	CQS	x	y	u	v	Δuv
4186 K	97.1	91.2	91.3	99.2	94.9	0.372	0.370	0.222	0.332	-0.0007

Note: specifications are representative of the diode type and not a particular tape light article.

4200K

Rf 91.3
Fidelity index Rf

Rg 99.2
Gammut index Rg

Hue Bin	R _f	Graphic shifts (%)	
		Chroma	Hue
1	93	-2%	1%
2	96	-1%	0%
3	95	-1%	1%
4	93	-3%	-2%
5	91	-5%	-1%
6	96	-2%	0%
7	93	-3%	2%
8	92	-2%	4%
9	88	-1%	9%
10	86	0%	7%
11	85	4%	8%
12	92	4%	2%
13	92	4%	-3%
14	94	0%	-1%
15	88	2%	-5%
16	88	1%	-6%

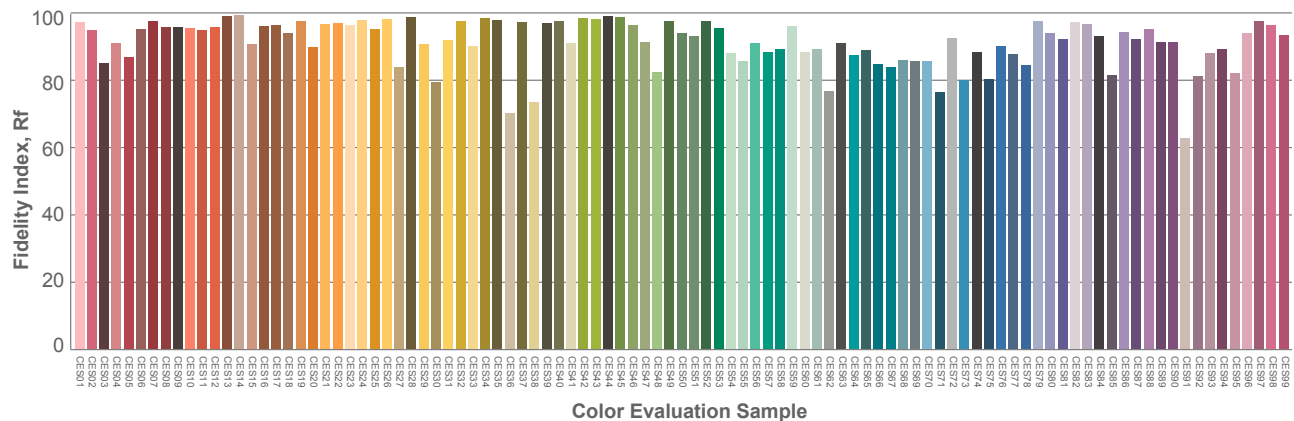
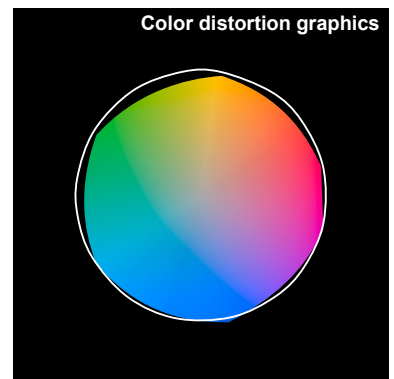
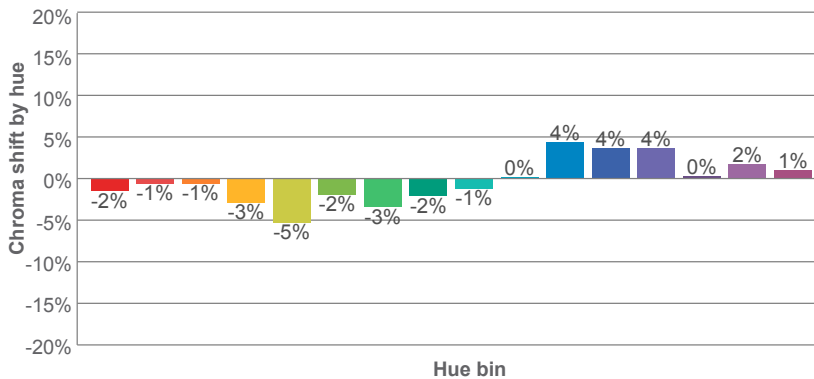
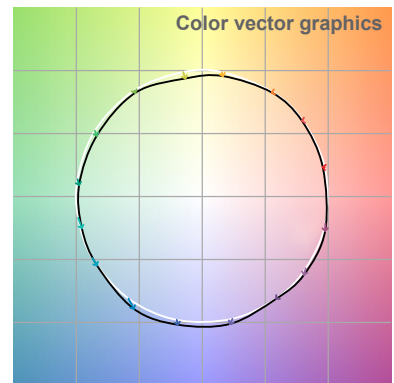
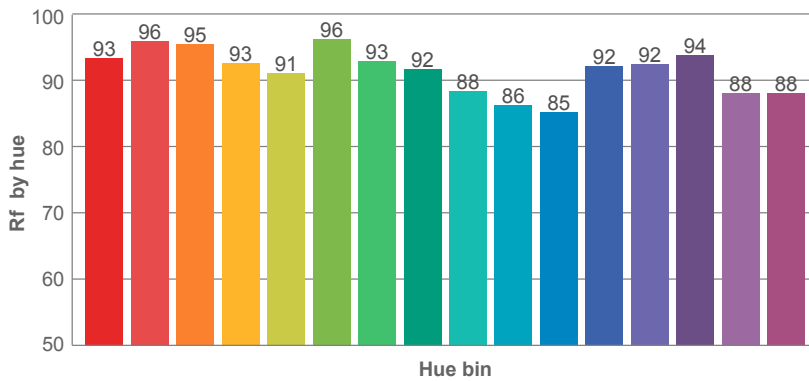
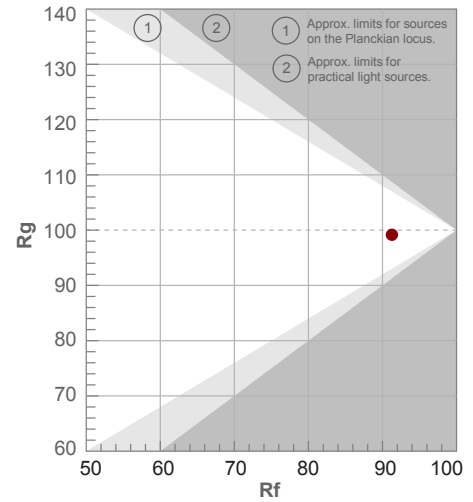

Note: specifications are representative of the diode type and not a particular tape light article.

4200K

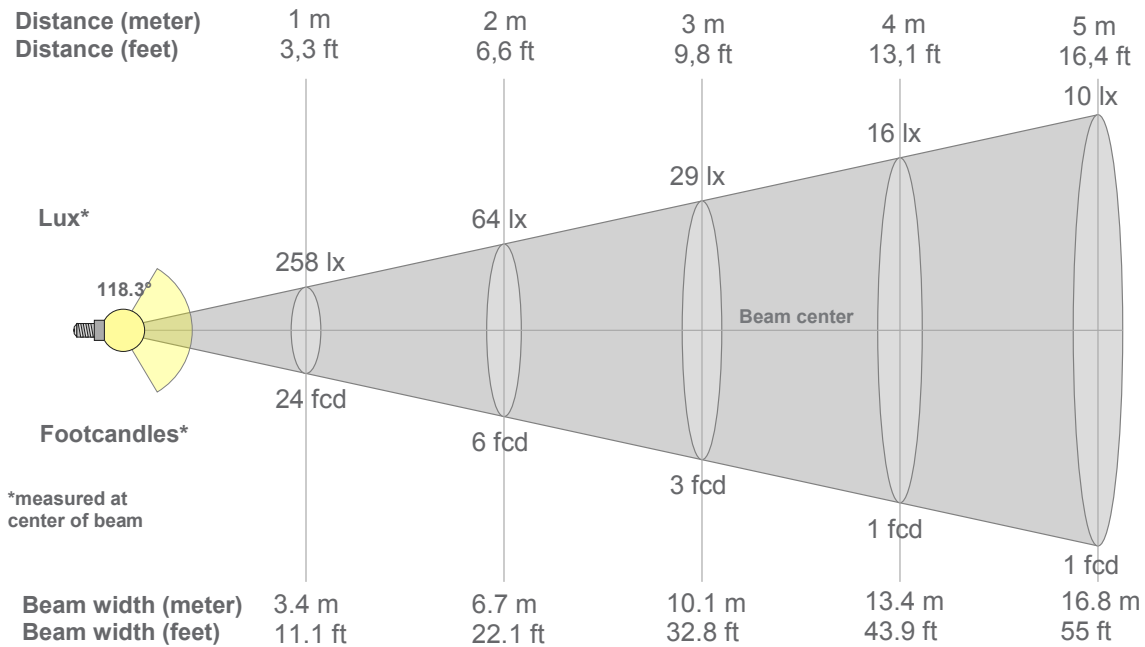

Beam intensities from 1-20m

1m	2m	3m	4m	5m	6m	7m	8m	9m	10m	11m	12m	13m	14m	15m	16m	17m	18m	19m	20m
3.3ft	6.6ft	9.8ft	13.1ft	16.4ft	19.7ft	23ft	26.2ft	29.5ft	32.8ft	36.1ft	39.4ft	42.7ft	45.9ft	49.2ft	52.5ft	55.8ft	59.1ft	62.3ft	65.6ft
258lx	64lx	29lx	16lx	10lx	7lx	5lx	4lx	3lx	3lx	2lx	2lx	2lx	1lx	1lx	1lx	1lx	1lx	1lx	1lx
23.9fcd	6fcd	2.7fcd	1.5fcd	1fcd	0.7fcd	0.5fcd	0.4fcd	0.3fcd	0.2fcd	0.2fcd	0.2fcd	0.2fcd	0.1fcd	0.1fcd	0.1fcd	0.1fcd	0.1fcd	0.1fcd	0.1fcd

Intensities in 0° c-plane

0°	5°	10°	15°	20°	25°	30°	35°	40°	45°	50°	55°	60°	65°	70°	75°	80°	85°	90°	95°
258	257	254	249	242	234	223	210	195	180	163	145	126	106	85	64	43	23	8	2
100%	100%	98%	97%	94%	91%	86%	82%	76%	70%	63%	56%	49%	41%	33%	25%	17%	9%	3%	1%

Intensities in 90° c-plane

0°	5°	10°	15°	20°	25°	30°	35°	40°	45°	50°	55°	60°	65°	70°	75°	80°	85°	90°	95°
258	257	254	249	242	234	223	210	195	180	163	145	126	106	85	64	43	23	8	2
100%	100%	98%	97%	94%	91%	86%	82%	76%	70%	63%	56%	49%	41%	33%	25%	17%	9%	3%	1%

Intensities in 180° c-plane

0°	5°	10°	15°	20°	25°	30°	35°	40°	45°	50°	55°	60°	65°	70°	75°	80°	85°	90°	95°
258	257	254	249	243	234	224	212	198	182	165	146	125	104	81	58	35	16	3	1
100%	100%	99%	97%	94%	91%	87%	82%	77%	71%	64%	57%	49%	40%	31%	22%	14%	6%	1%	0%

Intensities in 270° c-plane

0°	5°	10°	15°	20°	25°	30°	35°	40°	45°	50°	55°	60°	65°	70°	75°	80°	85°	90°	95°
258	257	254	249	243	234	224	212	198	182	165	146	125	104	81	58	35	16	3	1
100%	100%	99%	97%	94%	91%	87%	82%	77%	71%	64%	57%	49%	40%	31%	22%	14%	6%	1%	0%

Beam angle 50%	Field angle 10%	Cutoff angle 2,5%	Intensity ratio in 120° cone	Intensity ratio in 90° cone
118.3°	166.7°	178.8°	75.0%	50.2%

Note: specifications are representative of the diode type and not a particular tape light article.

5000K

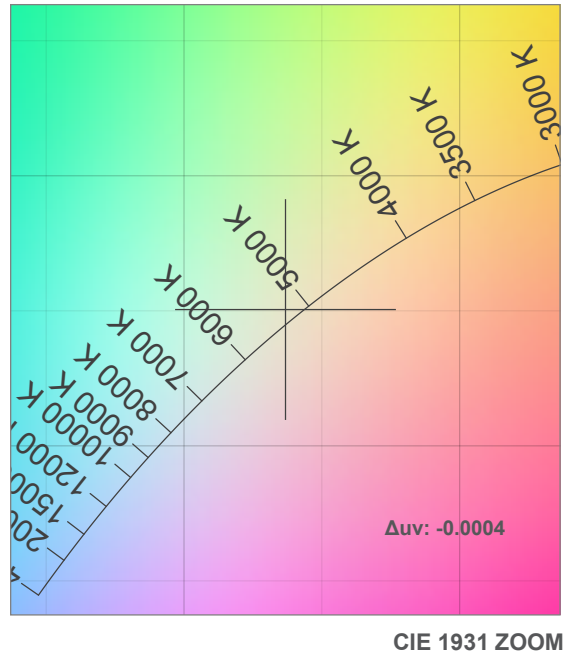
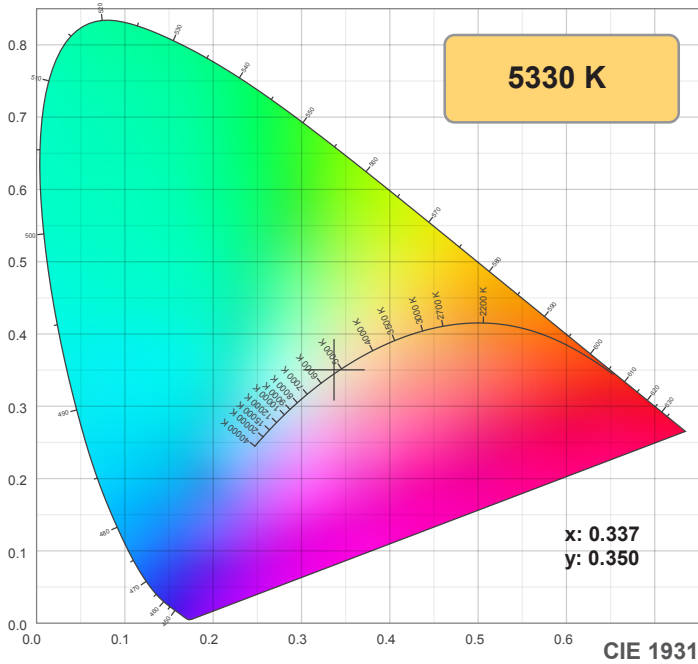

TM30: 87.0

CRI: 93.1 (R1-R8)

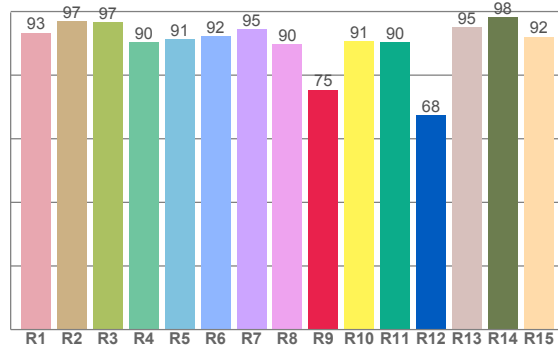
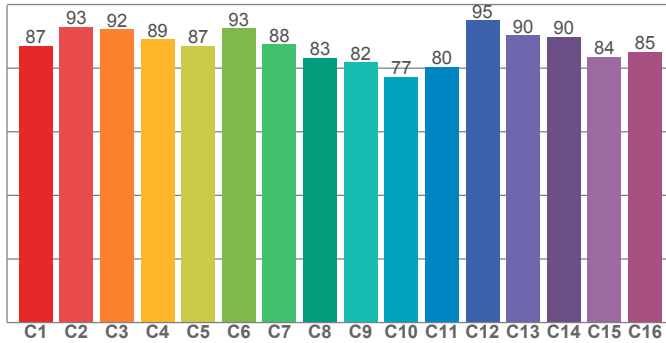

CRI R values, only R1-R8 are used to calculate final CRI value

R1	R2	R3	R4	R5	R6	R7	R8	R9	R10	R11	R12	R13	R14	R15
93.4	97.0	96.7	90.4	91.3	92.2	94.5	89.7	75.4	90.7	90.3	67.5	95.0	98.4	92.1

TM30 C values, 16 binned values out of total of 99 C values

C1	C2	C3	C4	C5	C6	C7	C8	C9	C10	C11	C12	C13	C14	C15	C16
87.0	93.1	92.2	89.1	87.0	92.6	87.5	83.3	81.8	77.3	80.4	95.1	90.3	89.9	83.6	85.1

CQS Q values

Q1	Q2	Q3	Q4	Q5	Q6	Q7	Q8	Q9	Q10	Q11	Q12	Q13	Q14	Q15
90.6	98.3	86.1	81.4	85.2	87.6	92.6	94.9	98.2	95.1	92.6	92.8	93.4	92.2	92.4

CQS: 90.4

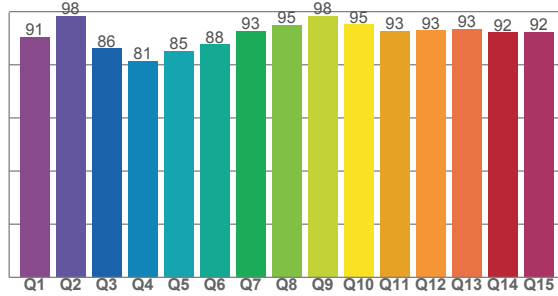

Color parameters

Color temperature	Color rendering index	Red component	Color fidelity	Color gamut	Color quality scale	Color coordinate cie 1931	Color coordinate cie 1931	Color coordinate	Color coordinate	Color deviation from black body
CCT	CRI	CRI R9	TM30 Rf	TM30 Rg	CQS	x	y	u	v	Δuv
5330 K	93.1	75.4	87.0	95.8	90.4	0.337	0.350	0.206	0.322	-0.0004

Note: specifications are representative of the diode type and not a particular tape light article.

5000K

Rf 87.0
Fidelity index Rf

Rg 95.8
Gammut index Rg

Hue Bin	R _f	Graphic shifts (%)	
		Chroma	Hue
1	87	-4%	1%
2	93	-2%	2%
3	92	-2%	1%
4	89	-4%	-1%
5	87	-7%	-1%
6	93	-4%	-1%
7	88	-7%	2%
8	83	-6%	6%
9	82	-5%	14%
10	77	-1%	13%
11	80	4%	10%
12	95	3%	0%
13	90	4%	-4%
14	90	0%	-5%
15	84	1%	-8%
16	85	-1%	-6%

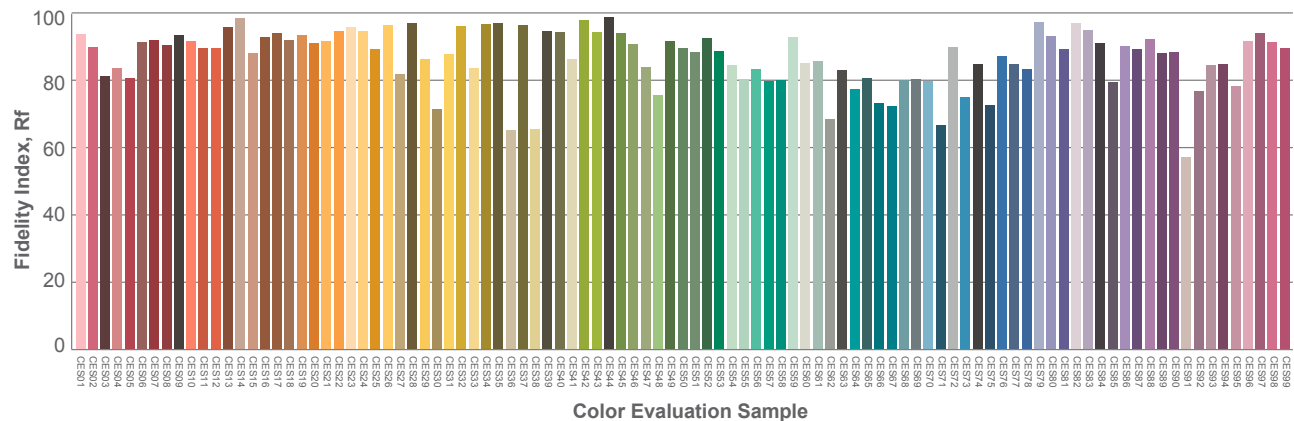
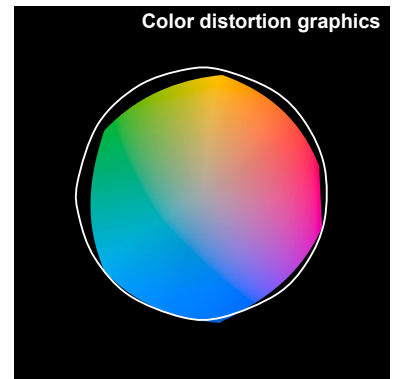
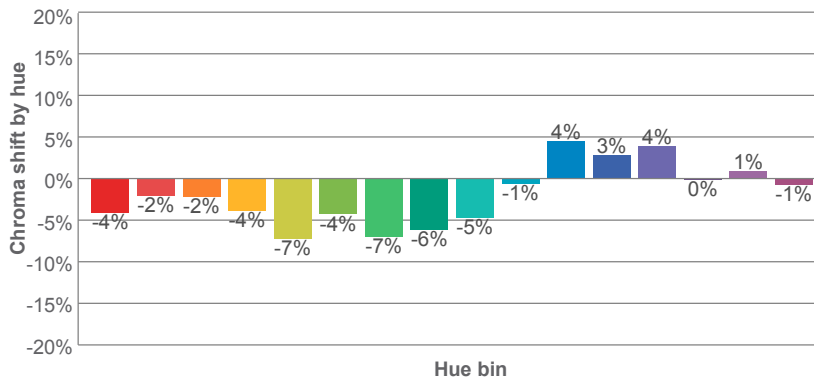
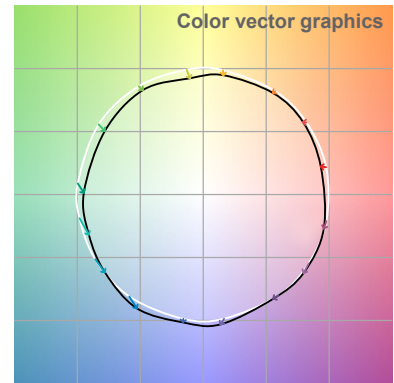
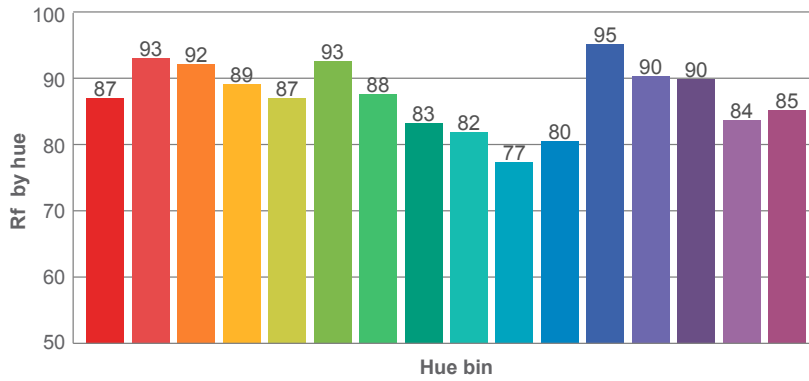
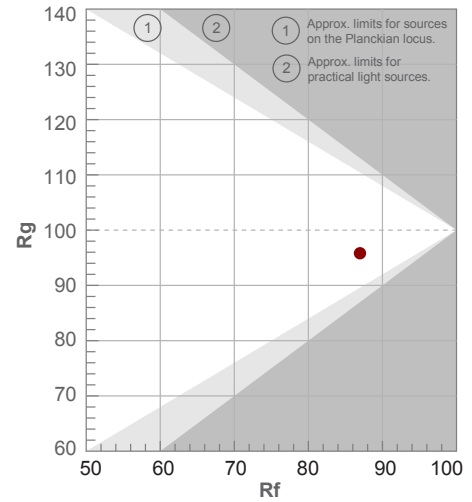

Note: specifications are representative of the diode type and not a particular tape light article.

5000K

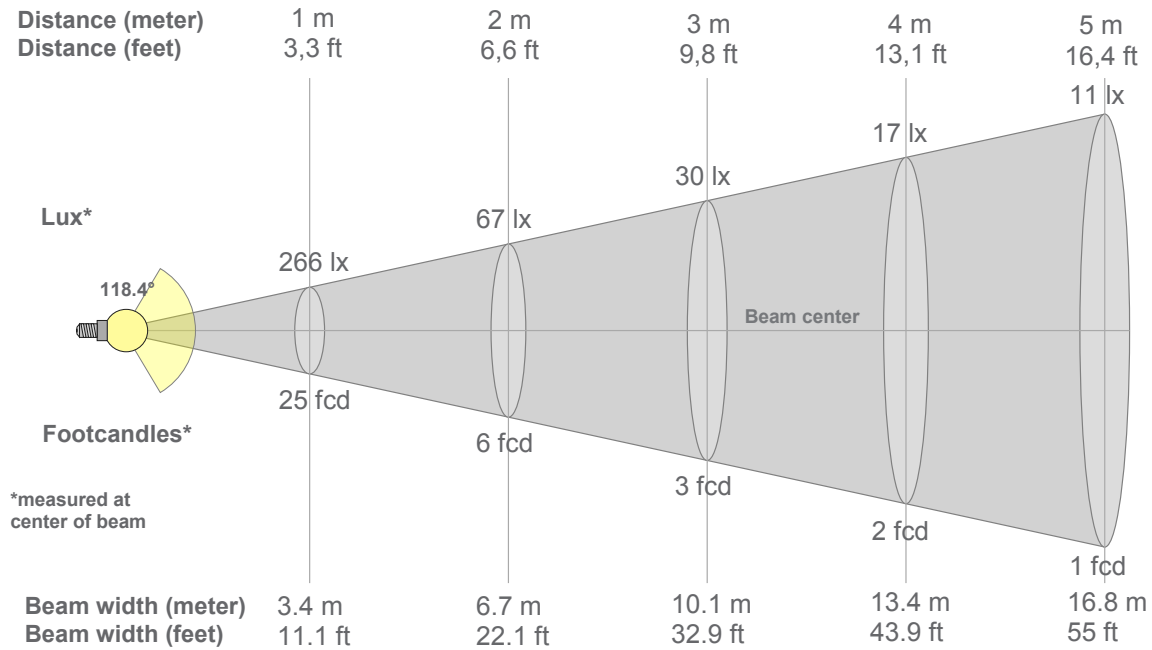

Beam intensities from 1-20m

1m	2m	3m	4m	5m	6m	7m	8m	9m	10m	11m	12m	13m	14m	15m	16m	17m	18m	19m	20m
3.3ft	6.6ft	9.8ft	13.1ft	16.4ft	19.7ft	23ft	26.2ft	29.5ft	32.8ft	36.1ft	39.4ft	42.7ft	45.9ft	49.2ft	52.5ft	55.8ft	59.1ft	62.3ft	65.6ft
266lx	67lx	30lx	17lx	11lx	7lx	5lx	4lx	3lx	3lx	2lx	2lx	2lx	1lx	1lx	1lx	1lx	1lx	1lx	1lx
24.8fcd	6.2fcd	2.8fcd	1.5fcd	1fcd	0.7fcd	0.5fcd	0.4fcd	0.3fcd	0.2fcd	0.2fcd	0.2fcd	0.2fcd	0.1fcd	0.1fcd	0.1fcd	0.1fcd	0.1fcd	0.1fcd	0.1fcd

Intensities in 0° c-plane

0°	5°	10°	15°	20°	25°	30°	35°	40°	45°	50°	55°	60°	65°	70°	75°	80°	85°	90°	95°
266	265	262	257	249	240	229	216	201	184	168	149	130	110	88	66	44	24	8	1
100%	99%	98%	96%	94%	90%	86%	81%	75%	69%	63%	56%	49%	41%	33%	25%	17%	9%	3%	1%

Intensities in 90° c-plane

0°	5°	10°	15°	20°	25°	30°	35°	40°	45°	50°	55°	60°	65°	70°	75°	80°	85°	90°	95°
266	265	262	257	249	240	229	216	201	184	168	149	130	110	88	66	44	24	8	1
100%	99%	98%	96%	94%	90%	86%	81%	75%	69%	63%	56%	49%	41%	33%	25%	17%	9%	3%	1%

Intensities in 180° c-plane

0°	5°	10°	15°	20°	25°	30°	35°	40°	45°	50°	55°	60°	65°	70°	75°	80°	85°	90°	95°
266	266	263	258	252	243	232	219	205	188	170	151	130	108	84	61	38	18	4	1
100%	100%	99%	97%	94%	91%	87%	82%	77%	71%	64%	57%	49%	40%	32%	23%	14%	7%	1%	0%

Intensities in 270° c-plane

0°	5°	10°	15°	20°	25°	30°	35°	40°	45°	50°	55°	60°	65°	70°	75°	80°	85°	90°	95°
266	266	263	258	252	243	232	219	205	188	170	151	130	108	84	61	38	18	4	1
100%	100%	99%	97%	94%	91%	87%	82%	77%	71%	64%	57%	49%	40%	32%	23%	14%	7%	1%	0%

Beam angle 50%	Field angle 10%	Cutoff angle 2,5%	Intensity ratio in 120° cone	Intensity ratio in 90° cone
118.4°	167.1°	179.3°	74.7%	50.0%