

PrimaLine® 5.5 LP (Low Profile) LED Tape Light

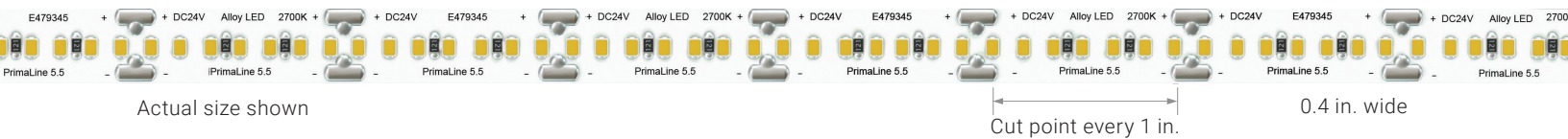

PrimaLine 5.5 LP is a low profile, very high output, dimmable LED light that is designed with specialized Diodes to emit a smooth, even line of continuous light. When installed in our Continua™ Aluminum Channels with a frosted cover, PrimaLine 5.5 creates hotspot-free light, even when reflected in a countertop or other high-gloss surface. This linear light supplies the perfect level of brightness for medium to large applications.

- New 2016 diodes
- Smooth, hotspot-free line of light
- Ultra low profile
- Industry-leading 95+ CRI (Color Rendering Index)
- One of the highest R9 and R13 values for superb rendering of warm tones

TECHNICAL INFORMATION

Stocked CCTs (Color Temperature)*	2700K, 3000K, 3500K, 4200K, 5000K
Power Consumption Per Foot	5.5 Watts/220mA
Input Voltage	24V DC
Diodes per foot	81
Diode Spacing	0.15 inches
Tape Height	0.07 inches
Beam Angle	120°
Field Cuttable (UL 2108)	Every 1 inch
Max Run Length	13 ft.
Dimmable	Yes

Diode Type	2016 SMD
Mounting	3M™ Self-Adhesive Tape (Non-porous)
Operating Temperature	-13° F to 140° F
Ambient Temperature	-40° F to 186° F
Spool Length**	13 ft., 26 ft. and 100 ft.
Environment	Indoor, Dry
Certifications	UL Listed, UL 2108, CE, RoHS
Standards	Certified to the CA Energy Commission in accordance with the Title 24 JA8 2016 std.
Warranty	6 Year Limited

* In addition to stocked colors, a wide variety of Color Temperatures is also available by special order. Please call or email to order.

**Each spool includes 36 in., 20 AWG tinned lead wires at both ends of the tape light.

NOTE: When soldering lead wires onto this tape light, set the soldering iron to 500° F. Also note that the product has adhesive tape on the back: soldering too long can compromise the tape light's internal components and adhesive integrity.

PRODUCT INFORMATION

13 ft. spool	26 ft. spool	100 ft. spool	Color Temperature	Watts per Foot	CRI	R9 Value	R13 Value	TM30	CQS	Lumens per Foot
AL-01-07-2411	AL-01-07-2431	AL-01-07-2441	● 2700K	5.5W	97.8	92.9	99.1	91.6	94.1	457
AL-01-07-2412	AL-01-07-2432	AL-01-07-2442	● 3000K	5.5W	97.2	95.1	98.3	90.6	93.8	465
AL-01-07-2418	AL-01-07-2438	AL-01-07-2448	● 3500K	5.5W	97.9	96.2	97.7	92.7	95.2	459
AL-01-07-2413	AL-01-07-2433	AL-01-07-2443	○ 4200K	5.5W	96.6	98	97.9	91.1	94.1	477
AL-01-07-2414	AL-01-07-2434	AL-01-07-2444	● 5000K	5.5W	96.1	90.2	99.7	89.9	93.3	462

VOLTAGE DROP GUIDANCE CHART

Standard Non-XT 24V Voltage Drop and Wire Length Distance Chart (3% Drop or 24V)

Wire Gauge	Copper Wire Resistance (Ω/kFT)	10W (0.42A)	20W (0.83A)	30W (1.25A)	40W (1.67A)	50W (2.08A)	60W (2.50A)	70W (2.92A)	80W (3.33A)	90W (3.75A)	96W (4A)
22 AWG	16.14	54 ft.	27 ft.	18 ft.	14 ft.	11 ft.	9 ft.	8 ft.	7 ft.	6 ft.	6 ft.
20 AWG	10.15	86 ft.	43 ft.	29 ft.	22 ft.	18 ft.	15 ft.	13 ft.	11 ft.	10 ft.	9 ft.
18 AWG	6.39	136 ft.	68 ft.	46 ft.	34 ft.	28 ft.	23 ft.	20 ft.	17 ft.	16 ft.	15 ft.
16 AWG	4.02	216 ft.	108 ft.	72 ft.	54 ft.	44 ft.	36 ft.	31 ft.	27 ft.	24 ft.	23 ft.
14 AWG	2.53	343 ft.	172 ft.	115 ft.	86 ft.	69 ft.	58 ft.	49 ft.	43 ft.	39 ft.	36 ft.
12 AWG	1.59	545 ft.	273 ft.	182 ft.	137 ft.	109 ft.	91 ft.	78 ft.	69 ft.	61 ft.	57 ft.
10 AWG	0.99	865 ft.	433 ft.	289 ft.	217 ft.	173 ft.	145 ft.	124 ft.	109 ft.	97 ft.	91 ft.

Note: These tables provide general guidelines for determining Wire Gauge based on total load and distance from LED driver to beginning of luminaire.

ACCESSORIES (SOLD SEPARATELY)

In-Wall-Rated Tape Light Connectors (20 AWG)

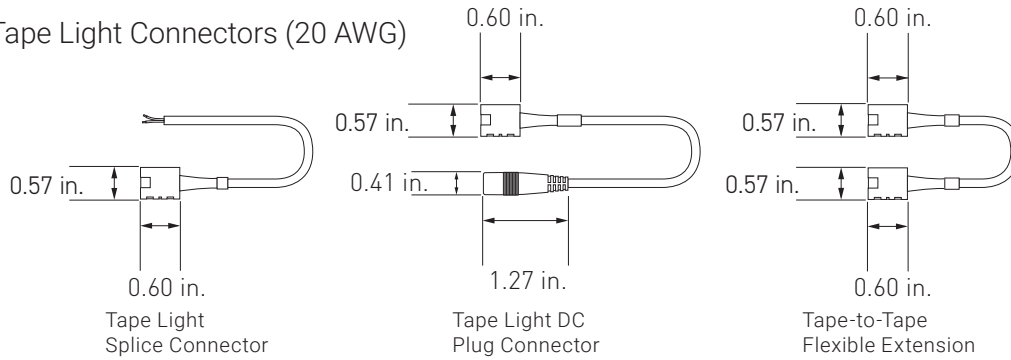

Item Number	Description	Wire Length
AL-01-07-9902	Tape Light Splice Connector	6 in.
AL-01-07-9907	Tape Light Splice Connector	36 in.
AL-01-07-9910	Tape Light Splice Connector	8 ft.

Item Number	Description	Wire Length
AL-01-07-9912	Tape-to-Tape Flexible Extension	6 in.
AL-01-07-9917	Tape-to-Tape Flexible Extension	36 in.
AL-01-07-9922	Tape Light DC Plug Connector	6 in.
AL-01-07-9927	Tape Light DC Plug Connector	36 in.

AmpChamp: For a more secure connection

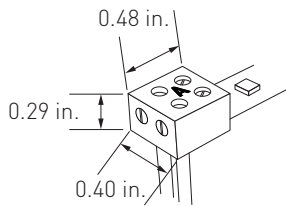
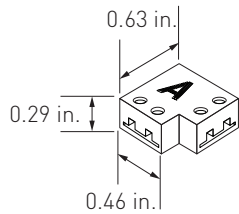
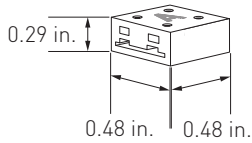

Accepts many combinations of tape and wire. Includes spade connectors for stranded wire, 3M[®] adhesive backing, and pre-attached 6 inch in-wall-rated 18 AWG lead wire.

Note: AmpChamp Corner does not include the pre-attached 6 inch in-wall-rated 18 AWG lead wire.

Straight AmpChamp

- AL-01-07-9900
- AL-01-07-9900-10 (10-pack)
- AL-01-07-9900-100 (100-pack)

AmpChamp Corner

- AL-01-07-9900-L

AmpChamp Up/Down

- AL-01-07-9900-UD
- AL-01-07-9900-UD-10 (10-pack)

AmpChamp Jumper and Power Feed Kits

AmpChamp Jumper Kit includes two standard AmpChamp Kits and one pre-tinned 18 AWG jumper wire.

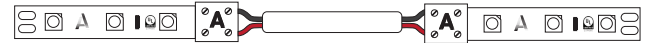

- AL-01-07-9900-3IN-JK (3 in. jumper wire)
- AL-01-07-9900-6IN-JK (6 in. jumper wire)
- AL-01-07-9900-36IN-JK (36 in. jumper wire)

AmpChamp Power Feed Kit includes one standard AmpChamp Kit and one pre-tinned 18 AWG power feed wire.

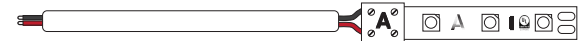

- AL-01-07-9900-36IN-PK (36 in. power feed wire)
- AL-01-07-9900-8FT-PK (8 ft. power feed wire)

Wire and Tape Light Management

We recommend the use of the wire and tape harness.

- At least 1 wire harness at the beginning to secure the lead wire; for longer lead wires, place a harness every 2 feet
- 1 tape harness every 2 feet and 1 harness at the end of the tape light to secure it

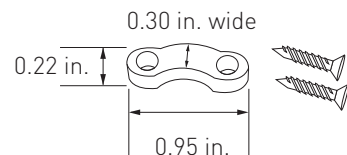

Wire Harness

Holds wire in place securely
AL-01-99-9901-10 (10-pack)

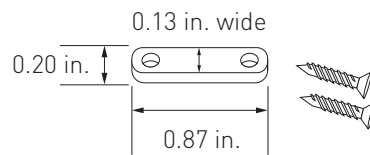

Tape Harness

Provides extra security for tape light, especially at the ends of a run
AL-01-99-9900-10 (10-pack)

Reduced Hotspot Pairings (Hotspot Rating from 0-5)

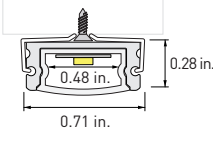
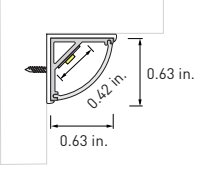
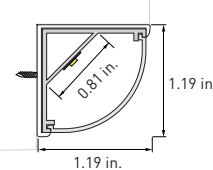
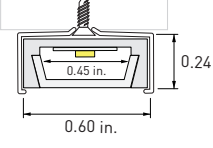
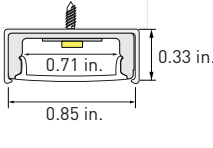
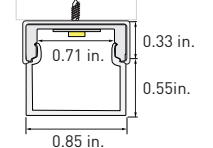
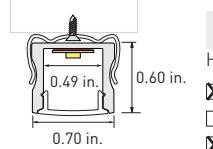
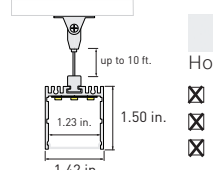
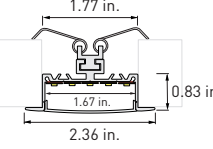
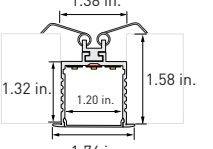
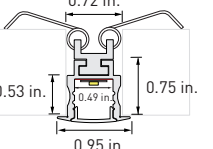
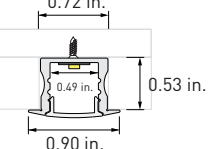
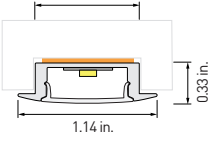
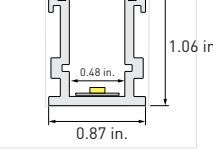
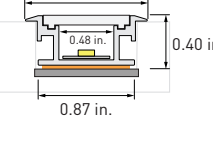
<p>Surfa 1: Surface-Mount</p>  <p>Hotspot Rating: 0</p> <ul style="list-style-type: none"> <input checked="" type="checkbox"/> Solder <input type="checkbox"/> Connector <input type="checkbox"/> AmpChamp 	<p>Surfa 2: Corner-Mount</p>  <p>Hotspot Rating: 0</p> <ul style="list-style-type: none"> <input checked="" type="checkbox"/> Solder <input type="checkbox"/> Connector <input type="checkbox"/> AmpChamp 	<p>Surfa 2X: Corner-Mount</p>  <p>Hotspot Rating: 0</p> <ul style="list-style-type: none"> <input checked="" type="checkbox"/> Solder <input checked="" type="checkbox"/> Connector <input checked="" type="checkbox"/> AmpChamp
<p>Surfa 3: Surface-Mount</p>  <p>Hotspot Rating: 0</p> <ul style="list-style-type: none"> <input checked="" type="checkbox"/> Solder <input type="checkbox"/> Connector <input type="checkbox"/> AmpChamp 	<p>Surfa 6: Surface-Mount</p>  <p>Hotspot Rating: 0</p> <ul style="list-style-type: none"> <input checked="" type="checkbox"/> Solder <input checked="" type="checkbox"/> Connector <input checked="" type="checkbox"/> AmpChamp 	<p>Surfa 6 Surround: Surface-Mount</p>  <p>Hotspot Rating: 0</p> <ul style="list-style-type: none"> <input checked="" type="checkbox"/> Solder <input checked="" type="checkbox"/> Connector <input checked="" type="checkbox"/> AmpChamp
<p>Surfa 7: Surface-Mount</p>  <p>Hotspot Rating: 0</p> <ul style="list-style-type: none"> <input checked="" type="checkbox"/> Solder <input type="checkbox"/> Connector <input checked="" type="checkbox"/> AmpChamp 	<p>Suspan 1: Suspended</p>  <p>Hotspot Rating: 0</p> <ul style="list-style-type: none"> <input checked="" type="checkbox"/> Solder <input checked="" type="checkbox"/> Connector <input checked="" type="checkbox"/> AmpChamp 	<p>Ankr 1: In-Wall</p>  <p>Hotspot Rating: 0</p> <ul style="list-style-type: none"> <input checked="" type="checkbox"/> Solder <input checked="" type="checkbox"/> Connector <input checked="" type="checkbox"/> AmpChamp
<p>Ankr 2: In-Wall</p>  <p>Hotspot Rating: 0</p> <ul style="list-style-type: none"> <input checked="" type="checkbox"/> Solder <input checked="" type="checkbox"/> Connector <input checked="" type="checkbox"/> AmpChamp 	<p>Ankr 3: In-Wall</p>  <p>Hotspot Rating: 0</p> <ul style="list-style-type: none"> <input checked="" type="checkbox"/> Solder <input type="checkbox"/> Connector <input checked="" type="checkbox"/> AmpChamp 	<p>Ankr 4: Mud-In</p>  <p>Hotspot Rating: 0</p> <ul style="list-style-type: none"> <input checked="" type="checkbox"/> Solder <input type="checkbox"/> Connector <input checked="" type="checkbox"/> AmpChamp
<p>Naro 4: Recessed</p>  <p>Hotspot Rating: 0</p> <ul style="list-style-type: none"> <input checked="" type="checkbox"/> Solder <input type="checkbox"/> Connector <input checked="" type="checkbox"/> AmpChamp 	<p>Duro 1: In-Ground</p>  <p>Hotspot Rating: 0</p> <ul style="list-style-type: none"> <input checked="" type="checkbox"/> Solder <input type="checkbox"/> Connector <input checked="" type="checkbox"/> AmpChamp 	<p>Duro 2: In-Ground</p>  <p>Hotspot Rating: 0</p> <ul style="list-style-type: none"> <input checked="" type="checkbox"/> Solder <input type="checkbox"/> Connector <input checked="" type="checkbox"/> AmpChamp

ALLOY LED[®] Specifications

COMPATIBLE CHANNELS (Diagrams below not to scale)

Reduced Hotspot Pairings (Hotspot Rating from 0-5)

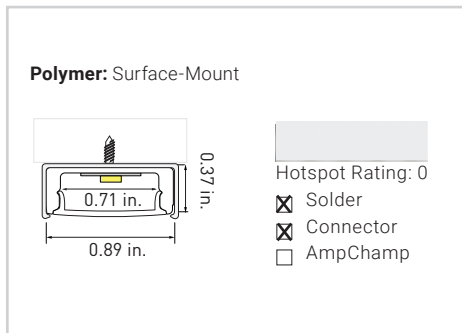

ALLOY LED[®] Specifications

RECOMMENDED POWER SUPPLIES (SOLD SEPARATELY)



Alloy LED PowerFactor™ Dimmable Power Supplies with Integrated UL Listed Junction Box
Compact, highly efficient, and code-compliant power supply with versatile and smooth dimming capabilities.

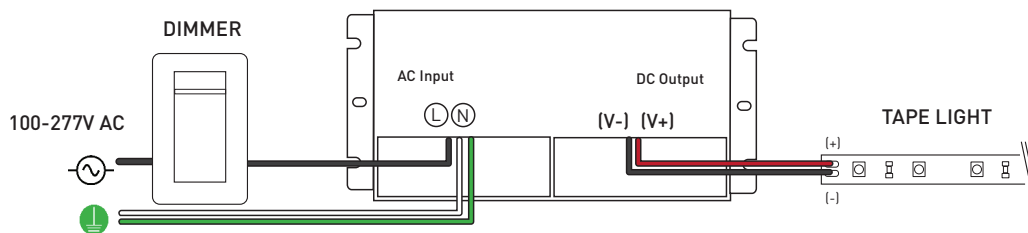

Wiring diagram is for reference only. Please refer to dimmer wiring specifications sheet for accurate directions.

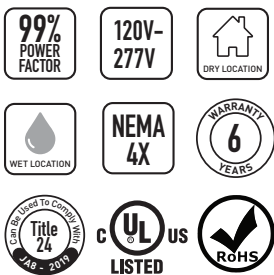

Single Tap Models

Item Number	Output Voltage	Wattage	Wet Location	Minimum Load	Dimensions (L x W x H)	Class 2
AL-98-10-12030	12V DC	30W	Yes (NEMA 4X)	10%	6.50 x 3.72 x 1.02 in.	Yes
AL-98-10-12060	12V DC	60W	Yes (NEMA 4X)	10%	7.40 x 3.72 x 1.02 in.	Yes
AL-98-10-12120	12V DC	120W	Yes (NEMA 4X)	10%	8.66 x 3.72 x 1.57 in.	No
AL-98-10-24030	24V DC	30W	Yes (NEMA 4X)	10%	6.50 x 3.72 x 1.02 in.	Yes
AL-98-10-24060	24V DC	60W	Yes (NEMA 4X)	10%	7.40 x 3.72 x 1.02 in.	Yes
AL-98-10-24096	24V DC	96W	Yes (NEMA 4X)	10%	8.66 x 3.72 x 1.57 in.	Yes
AL-98-10-24150	24V DC	150W	Yes (NEMA 4X)	10%	10.24 x 4.13 x 1.77 in.	No
AL-98-10-24200	24V DC	200W	Yes (NEMA 4X)	10%	10.24 x 4.13 x 1.77 in.	No
AL-98-10-24300	24V DC	300W	Yes (NEMA 4X)	10%	10.94 x 4.33 x 1.77 in.	No

Class 2 Compliant Multi-Tap Models

Item Number	Output Voltage	Wattage	Wet Location	Minimum Load	Dimensions (L x W x H)	Class 2
AL-98-10-12300-MT	12V DC	300W	Yes (NEMA 4X)	10%	11.85 x 4.33 x 1.77 in.	Yes
AL-98-10-24192-MT	24V DC	192W	Yes (NEMA 4X)	10%	10.94 x 4.33 x 1.77 in.	Yes
AL-98-10-24288-MT	24V DC	288W	Yes (NEMA 4X)	10%	11.85 x 4.33 x 1.77 in.	Yes

Note: PowerFactor assumes 80% load.
Inspectors prefer power supply to be used with junction box.
For dimmer compatibility, refer to drivers specification sheet.

ALLOY LED[®] Specifications

RECOMMENDED POWER SUPPLIES (SOLD SEPARATELY)

Alloy LED Primavolt[®] No Minimum Load Dimmable Power Supplies with ETL Listed Junction Box
Code-compliant power supply with versatile and smooth dimming capabilities. Compatible with Incandescent, On/Off, ELV and MLV dimmers.

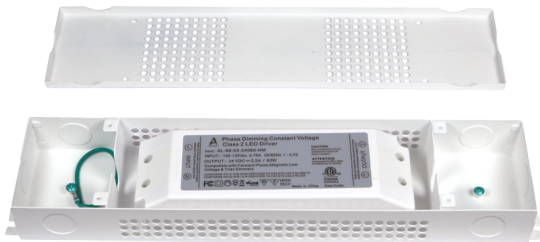

Dry Location Model
White model for 60W and lower



Wet Location Model
Black model for 80W and higher

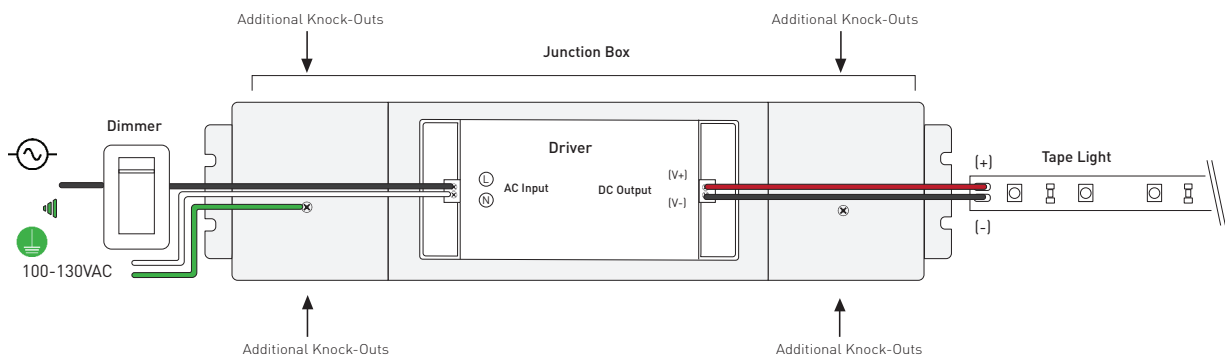

Wiring diagram is for reference only. Please refer to dimmer wiring specifications sheet for accurate directions.

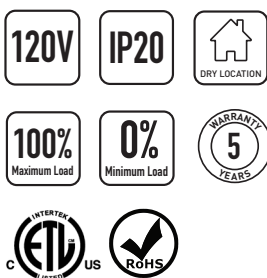

Item Number	Output Voltage	Wattage	Minimum Load	Dimensions (Junction Box) (L x W x H)	Class 2
AL-98-03-12024-NM	12V DC	24W	0%	13.78 x 3.03 x 1.46 in.	Yes
AL-98-03-12048-NM	12V DC	48W	0%	13.78 x 3.03 x 1.46 in.	Yes
AL-98-03-12060-NM	12V DC	60W	0%	13.78 x 3.03 x 1.46 in.	Yes
AL-98-03-12080-NM	12V DC	80W	0%	14.96 x 3.03 x 2.24 in.	No
AL-98-03-12120-NM	12V DC	120W	0%	14.96 x 3.03 x 2.24 in.	No
AL-98-03-24024-NM	24V DC	24W	0%	13.78 x 3.03 x 1.46 in.	Yes
AL-98-03-24048-NM	24V DC	48W	0%	13.78 x 3.03 x 1.46 in.	Yes
AL-98-03-24060-NM	24V DC	60W	0%	13.78 x 3.03 x 1.46 in.	Yes
AL-98-03-24080-NM	24V DC	80W	0%	14.96 x 3.03 x 2.24 in.	Yes
AL-98-03-24096-NM	24V DC	96W	0%	14.96 x 3.03 x 2.24 in.	Yes
AL-98-03-24150-NM	24V DC	150W	0%	15.98 x 3.43 x 2.36 in.	No
AL-98-03-24200-NM	24V DC	200W	0%	15.98 x 3.43 x 2.36 in.	No

Note: Alloy LED strongly recommends using Listed Class 2 power supplies for all installations. Always install in accordance with local and national electrical code regulations. Inspectors prefer power supply to be used with junction box. For dimmer compatibility, refer to drivers specification sheet.

ALLOY LED[®] Specifications

RECOMMENDED POWER SUPPLIES (SOLD SEPARATELY)

ELV Dimmable Power Supplies for Remote Enclosures

The drivers are derated, but when installed in a small enclosure with no heatsink or air circulation, we recommend a maximum load of 40W.

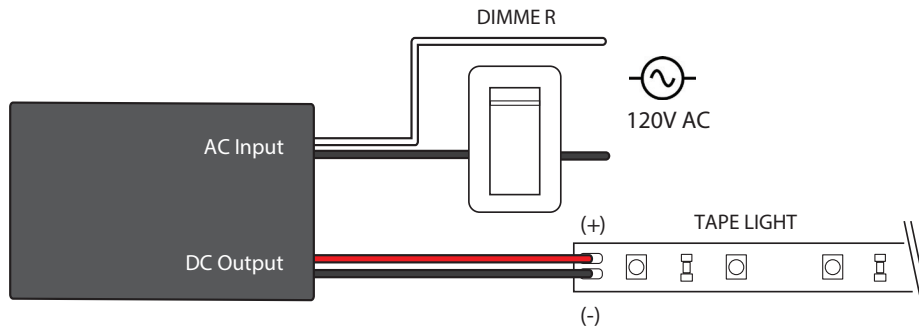

Wiring diagram is for reference only. Please refer to dimmer wiring specifications sheet for accurate directions.

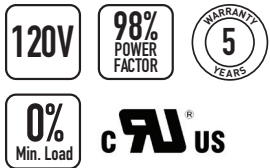

Item Number	Output	Wattage	Dimensions (L x W x H)	Class 2
AL-98-08-12060	12V DC	60W	2.66 x 1.30 x 0.83 in.	Yes
AL-98-08-24060	24V DC	60W	2.66 x 1.30 x 0.83 in.	Yes

Note: Inspectors prefer power supply to be used with junction box.
For dimmer compatibility, refer to drivers specification sheet.

ALLOY LED[®] Specifications

DIMMING ACCESSORIES (SOLD SEPARATELY)

Lutron[®] Dimming Accessories

By participating in Lutron's OEM Advantage program, Alloy LED is able to offer a range of the highest quality low voltage power supplies and selected controls on the market.



Hi-lume Premier
0.1% EcoSystem /
3-wire LED Driver
(96W 24VDC)



Hi-lume 1% LED Driver 40W
- EcoSystem / 3-wire control
- 2-wire 120V forward
phase control



Lutron Vive PowPak RF Module
- RF module for EcoSystem LED
driver control
- Use with the Lutron EcoSystem
drivers shown to "Vive-enable"
Alloy LED products

Lutron[®] Hi-lume LED Drivers

Item Number	Output	Wattage	Minimum Load	Class 2
AL-98-07-12040	12V DC	40W	N/A	Yes
AL-98-07-12040-3WIRE	12V DC	40W	N/A	Yes
AL-98-07-24040	24V DC	40W	N/A	Yes
AL-98-07-24040-3WIRE	24V DC	40W	N/A	Yes
AL-98-07-24096-3WIRE	24V DC	96W	N/A	Yes

Lutron[®] Controls

Item Number	Description	Voltage
AL-98-07-9901	EcoSystem Control Module	N/A
AL-98-07-9901-8	EcoSystem Control Module - 8-pack	N/A
AL-98-07-9950	CL Dimmer	120V AC
AL-98-07-9950-FPLATE	CL Dimmer faceplate	N/A

DIMMING ACCESSORIES (SOLD SEPARATELY)

Dimmers and Switches

SlimDim Wireless Dimmer Switch

Using long-range RF technology, these LED dimmers connect wirelessly to a receiver, offering freedom to mount anywhere. Can also be used as a fob for mobile, hand-held control.

AL-70-01-0001	SlimDim Wireless Dimmer
AL-70-01-0002	Single Color Receiver (96W max.) (sold separately)
AL-98-07-9950 -FPLATE	SlimDim Wall Plate (sold separately)

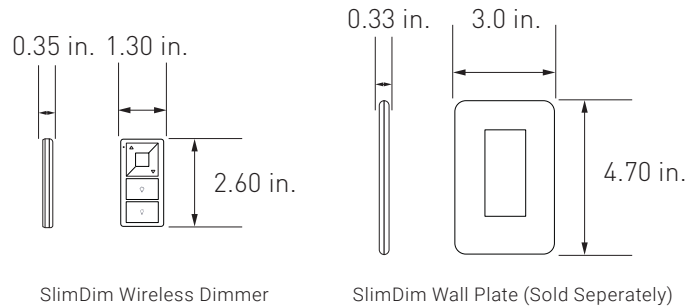

Remote Control Dimmer Switch

Provides full dimming and on/off control, and includes a touch wheel that allows for direct visual selection of brightness. It can also operate up to four independent zones.

AL-60-03-0001	Remote Control Dimmer Switch
AL-70-01-0002	Single Channel Receiver (sold separately)
AL-60-03-0004-V2	Wireless Receiver (RGB & RGBW) (sold separately)

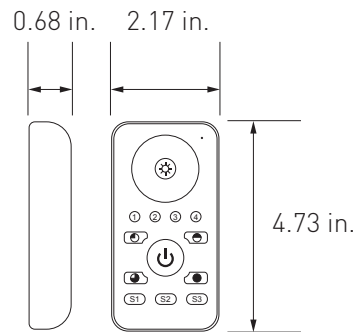

Single Channel Wireless Receiver

Pair with the Remote Control Dimmer Switch or the SlimDim Wireless Dimmer to dim PrimaLine tape lights. Use one remote to make independent lighting zones with multiple receivers with certain controllers.

AL-70-01-0002	Single Channel Wireless Receiver
---------------	----------------------------------

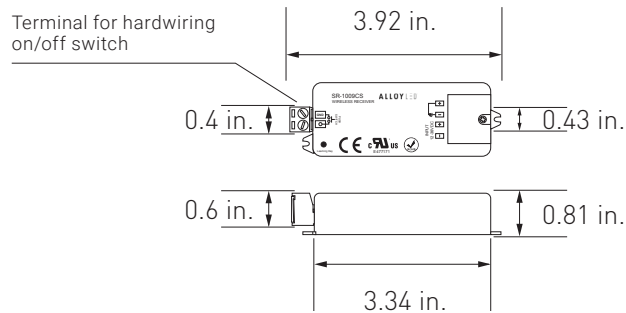

WIRING DIAGRAM

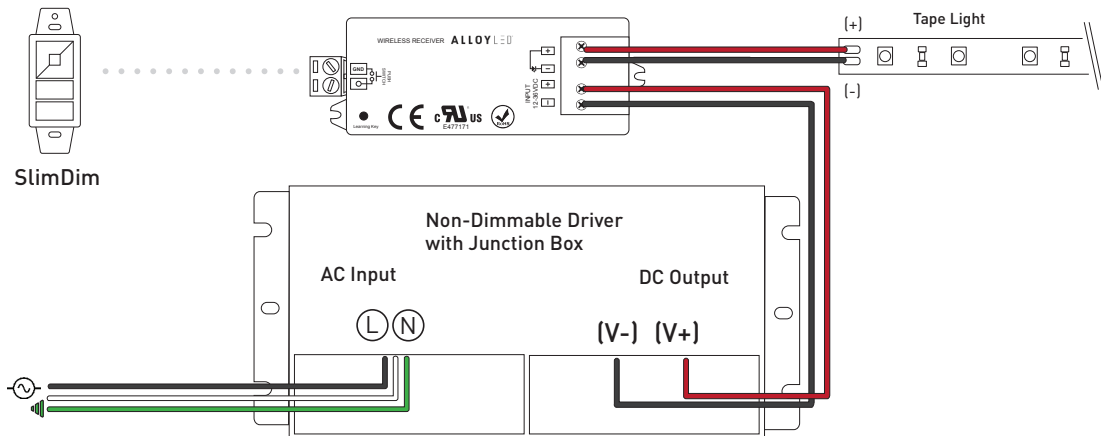

ALLOY LED[®] Specifications

RECOMMENDED POWER SUPPLIES (SOLD SEPARATELY)

Alloy LED TRIAC/MLV/ELV Dimmable Drivers for Remote Locations

Offers stable power in even in the most remote settings. Compatibility with TRIAC, ELV, or MLV dimmers.

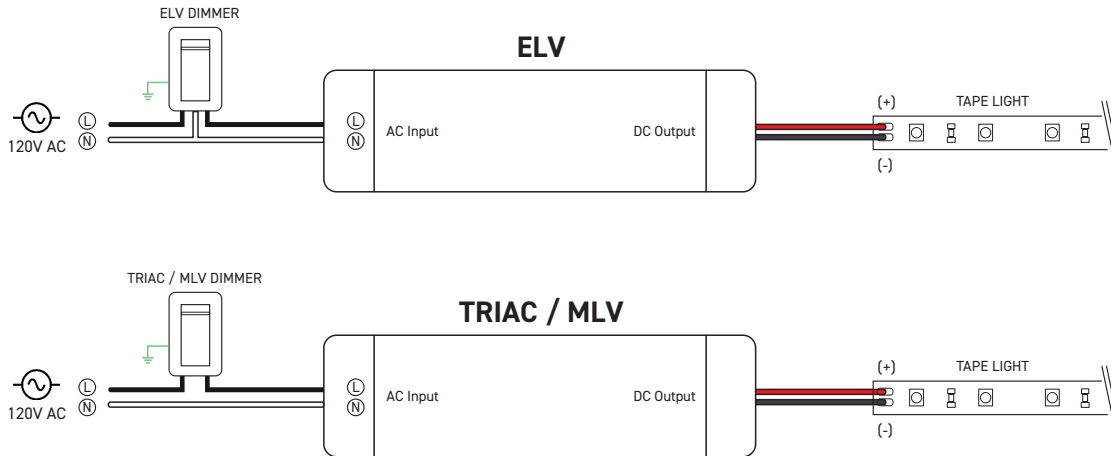
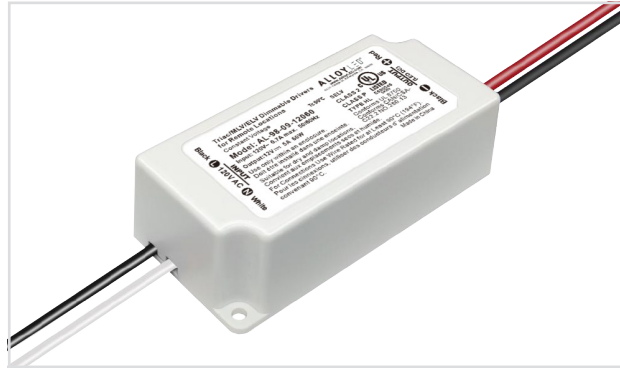

Wiring diagram is for reference only. Please refer to dimmer wiring specifications sheet for accurate directions.

120V

100%
Maximum Load

20%
Min. Load

DRY LOCATION

UL[®] US LISTED

CLASS 2

CLASS P

TYPE HL

SELV

WARRANTY 5 YEARS

Item Number	Output Voltage	Wattage	Dimensions (L x W x H)	Class 2
AL-98-09-12060	12V DC	60W	3.31 x 1.57 x 0.98	Yes
AL-98-09-24096	24V DC	96W	3.31 x 1.57 x 0.98	Yes

Note: Alloy LED strongly recommends using Listed Class 2 power supplies for all installations. Always install in accordance with local and national electrical code regulations. Inspectors prefer power supply to be used with junction box. For dimmer compatibility, refer to drivers specification sheet.

Note: specifications are representative of the diode type and not a particular tape light article.

2700K

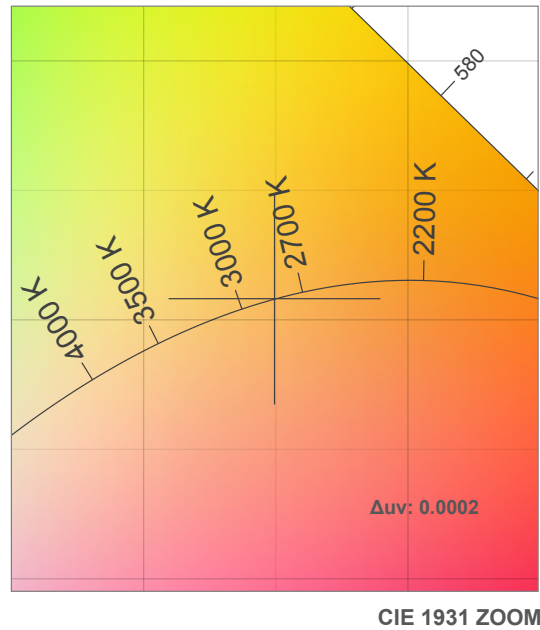
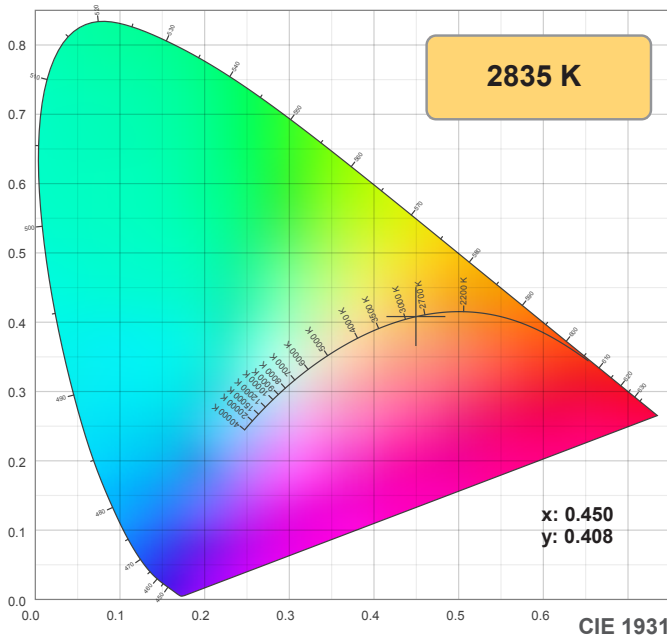

TM30: 91.6

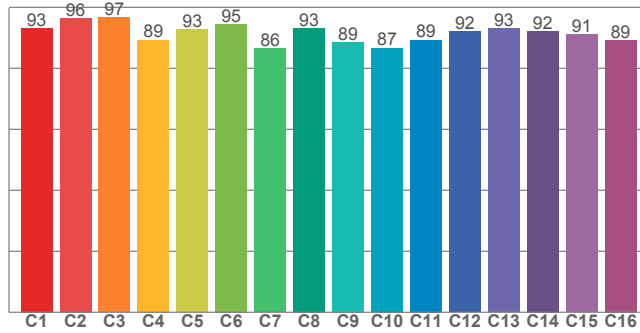

CRI: 97.8 (R1-R8)

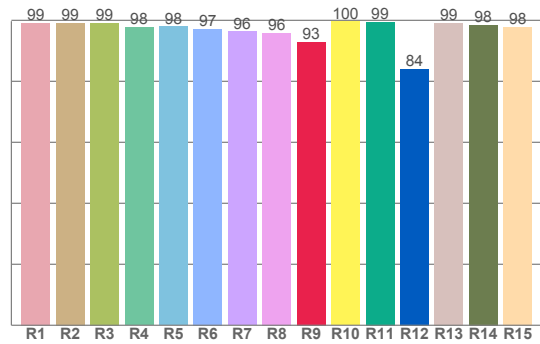

CRI R values, only R1-R8 are used to calculate final CRI value

R1	R2	R3	R4	R5	R6	R7	R8	R9	R10	R11	R12	R13	R14	R15
99.1	99.1	99.1	97.6	97.9	97.2	96.3	95.8	92.9	99.6	99.4	84.0	99.1	98.4	97.8

TM30 C values, 16 binned values out of total of 99 C values

C1	C2	C3	C4	C5	C6	C7	C8	C9	C10	C11	C12	C13	C14	C15	C16
93.2	96.5	96.6	89.3	92.7	94.5	86.5	93.2	88.6	86.7	89.4	92.1	93.1	92.2	91.0	89.2

CQS Q values

Q1	Q2	Q3	Q4	Q5	Q6	Q7	Q8	Q9	Q10	Q11	Q12	Q13	Q14	Q15
89.9	94.7	94.1	92.0	91.9	92.7	97.2	97.5	96.0	96.0	97.7	97.8	98.0	95.6	93.6

CQS: 94.1

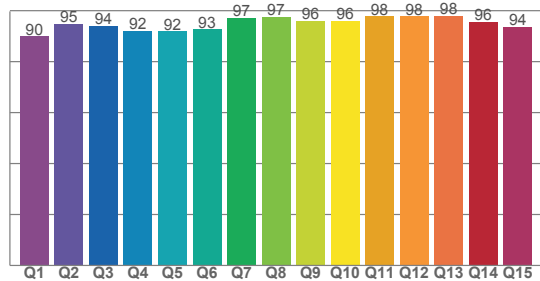

Color parameters

Color temperature	Color rendering index	Red component	Color fidelity	Color gamut	Color quality scale	Color coordinate cie 1931	Color coordinate cie 1931	Color coordinate	Color coordinate	Color deviation from black body
CCT	CRI	CRI R9	TM30 Rf	TM30 Rg	CQS	x	y	u	v	Δuv
2835 K	97.8	92.9	91.6	98.0	94.1	0.450	0.408	0.257	0.350	0.0002

Note: specifications are representative of the diode type and not a particular tape light article.

2700K

Rf 91.6
Fidelity index Rf

Rg 98.0
Gammut index Rg

Hue Bin	R _f	Graphic shifts (%)	
		Chroma	Hue
1	93	-1%	2%
2	96	0%	0%
3	97	-1%	-1%
4	89	-6%	-4%
5	93	-5%	0%
6	95	-3%	2%
7	86	-5%	6%
8	93	-1%	4%
9	89	0%	7%
10	87	2%	8%
11	89	5%	6%
12	92	4%	-1%
13	93	0%	-5%
14	92	2%	-5%
15	91	-3%	1%
16	89	0%	-7%

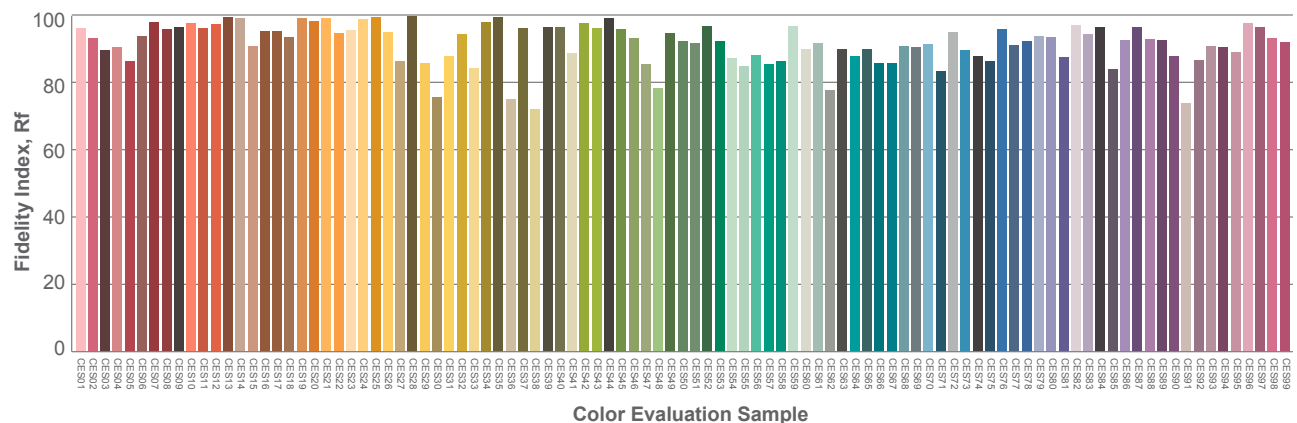
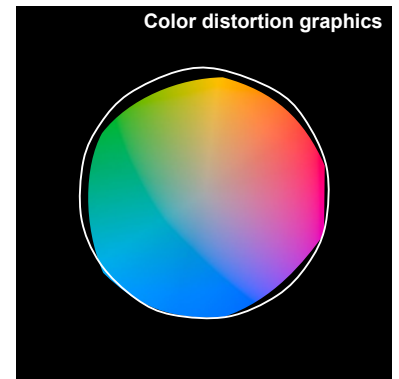
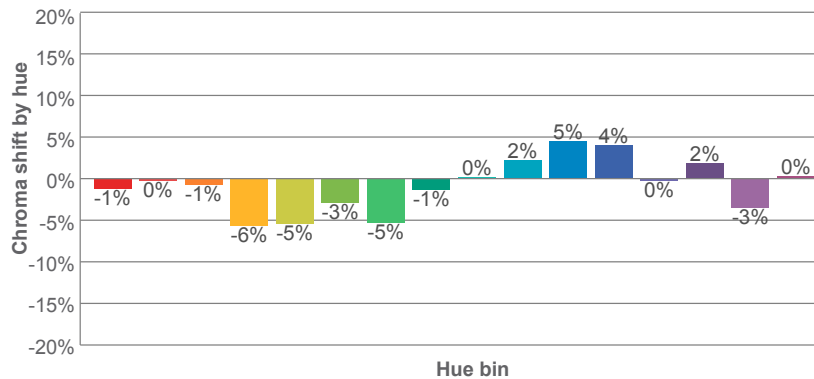
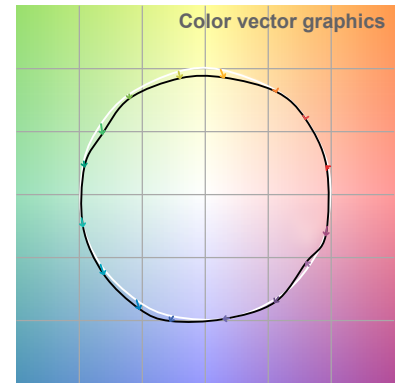
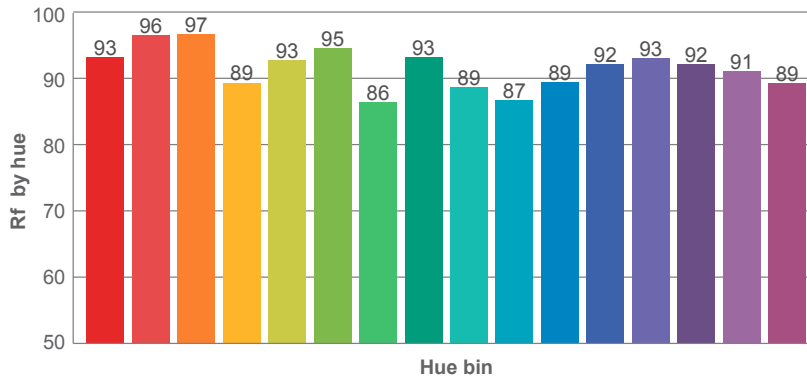
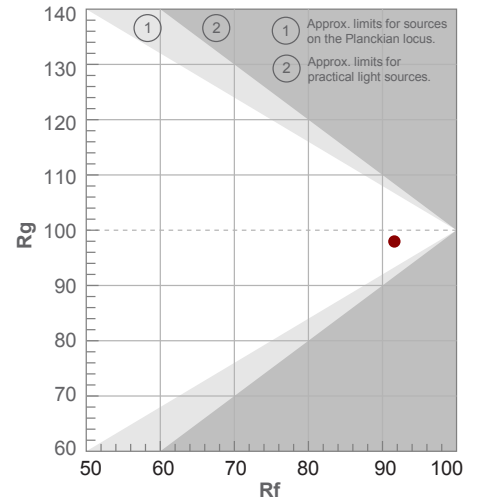

Note: specifications are representative of the diode type and not a particular tape light article.

2700K

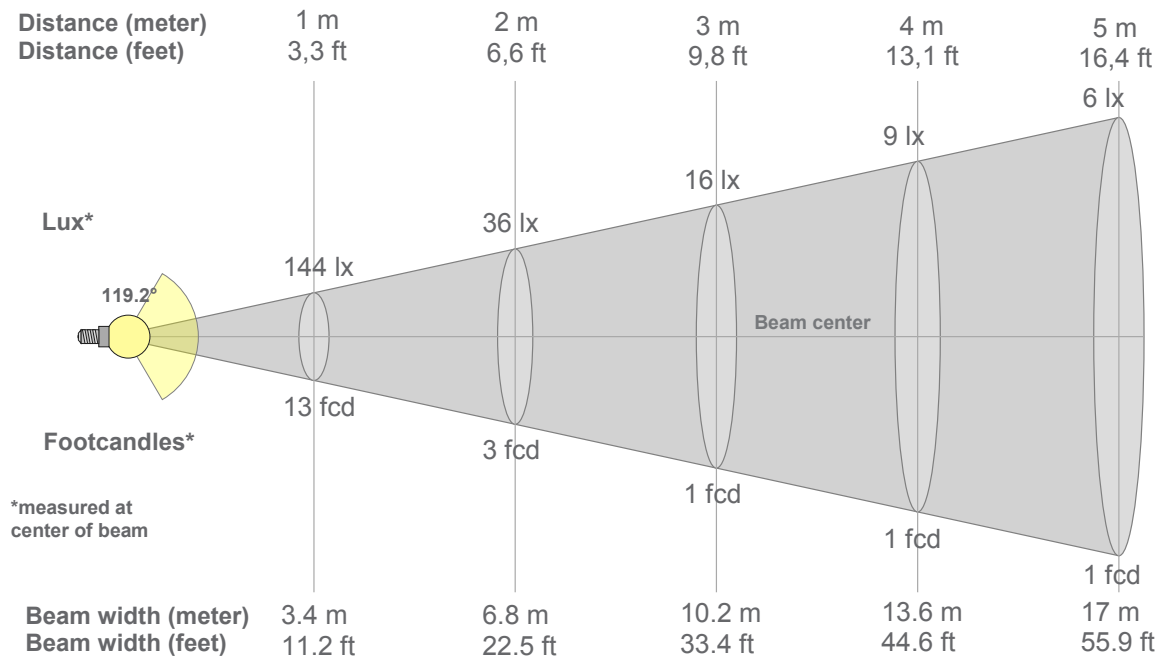

Beam intensities from 1-20m

1m	2m	3m	4m	5m	6m	7m	8m	9m	10m	11m	12m	13m	14m	15m	16m	17m	18m	19m	20m
3.3ft	6.6ft	9.8ft	13.1ft	16.4ft	19.7ft	23ft	26.2ft	29.5ft	32.8ft	36.1ft	39.4ft	42.7ft	45.9ft	49.2ft	52.5ft	55.8ft	59.1ft	62.3ft	65.6ft
144lx	36lx	16lx	9lx	6lx	4lx	3lx	2lx	2lx	1lx	1lx	1lx	1lx	1lx	1lx	1lx	0lx	0lx	0lx	0lx
13.4fcd	3.3fcd	1.5fcd	0.8fcd	0.5fcd	0.4fcd	0.3fcd	0.2fcd	0.2fcd	0.1fcd	0.1fcd	0.1fcd	0.1fcd	0.1fcd	0.1fcd	0.1fcd	0fcd	0fcd	0fcd	0fcd

Intensities in 0° c-plane

0°	5°	10°	15°	20°	25°	30°	35°	40°	45°	50°	55°	60°	65°	70°	75°	80°	85°	90°	95°
144	143	141	138	134	128	123	116	108	100	91	82	71	60	48	36	24	13	4	1
100%	100%	98%	96%	93%	89%	85%	80%	75%	70%	63%	57%	49%	42%	33%	25%	17%	9%	3%	1%

Intensities in 90° c-plane

0°	5°	10°	15°	20°	25°	30°	35°	40°	45°	50°	55°	60°	65°	70°	75°	80°	85°	90°	95°
144	143	141	138	134	128	123	116	108	100	91	82	71	60	48	36	24	13	4	1
100%	100%	98%	96%	93%	89%	85%	80%	75%	70%	63%	57%	49%	42%	33%	25%	17%	9%	3%	1%

Intensities in 180° c-plane

0°	5°	10°	15°	20°	25°	30°	35°	40°	45°	50°	55°	60°	65°	70°	75°	80°	85°	90°	95°
144	143	142	139	136	131	125	118	110	101	92	82	71	60	48	36	24	13	4	1
100%	100%	99%	97%	94%	91%	87%	82%	76%	71%	64%	57%	49%	41%	33%	25%	16%	9%	3%	1%

Intensities in 270° c-plane

0°	5°	10°	15°	20°	25°	30°	35°	40°	45°	50°	55°	60°	65°	70°	75°	80°	85°	90°	95°
144	143	142	139	136	131	125	118	110	101	92	82	71	60	48	36	24	13	4	1
100%	100%	99%	97%	94%	91%	87%	82%	76%	71%	64%	57%	49%	41%	33%	25%	16%	9%	3%	1%

Beam angle 50%	Field angle 10%	Cutoff angle 2,5%	Intensity ratio in 120° cone	Intensity ratio in 90° cone
119.2°	168.3°	181.6°	73.7%	49.1%

Note: specifications are representative of the diode type and not a particular tape light article.

3000K

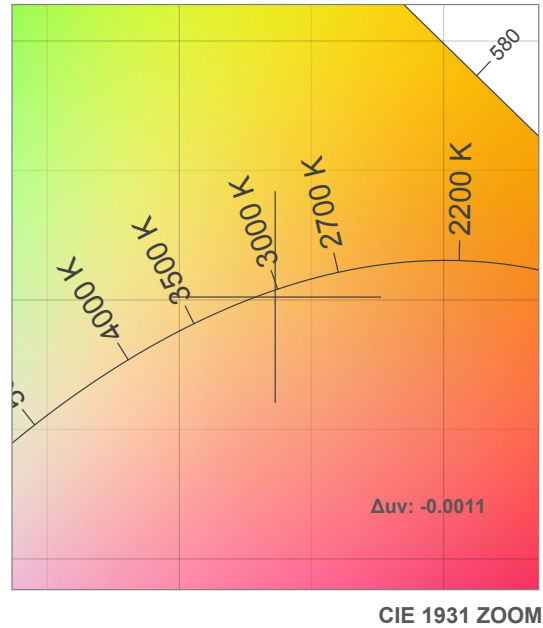
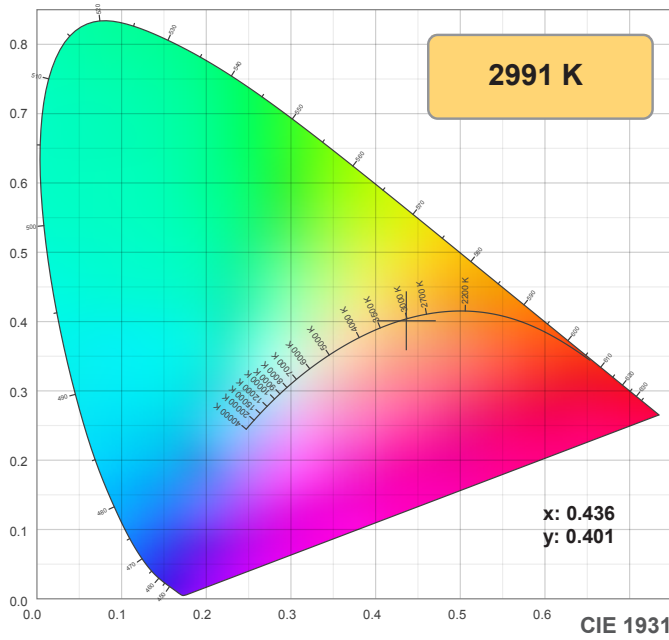

TM30: 90.6

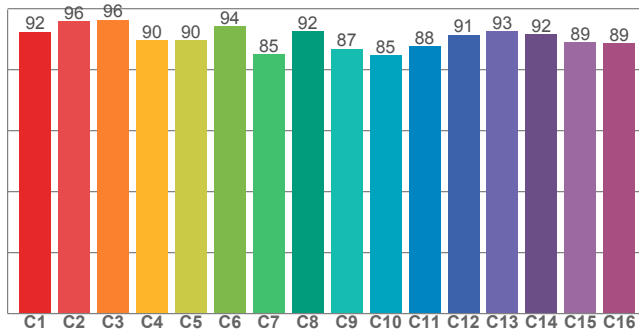

CRI: 97.2 (R1-R8)

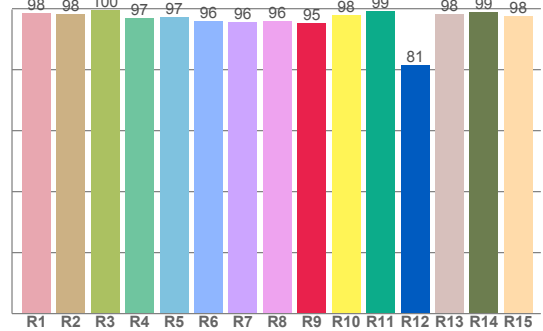

CRI R values, only R1-R8 are used to calculate final CRI value

R1	R2	R3	R4	R5	R6	R7	R8	R9	R10	R11	R12	R13	R14	R15
98.5	98.2	99.5	97.0	97.3	96.1	95.5	95.9	95.1	98.0	99.1	81.4	98.3	99.0	97.6

TM30 C values, 16 binned values out of total of 99 C values

C1	C2	C3	C4	C5	C6	C7	C8	C9	C10	C11	C12	C13	C14	C15	C16
92.4	95.8	96.3	89.7	89.7	94.2	85.0	92.5	86.9	84.8	87.7	91.4	92.7	91.5	89.1	88.6

CQS Q values

Q1	Q2	Q3	Q4	Q5	Q6	Q7	Q8	Q9	Q10	Q11	Q12	Q13	Q14	Q15
89.4	94.9	93.6	90.8	90.8	92.0	97.4	96.9	97.6	98.2	97.8	97.8	97.5	95.4	93.3

CQS: 93.8

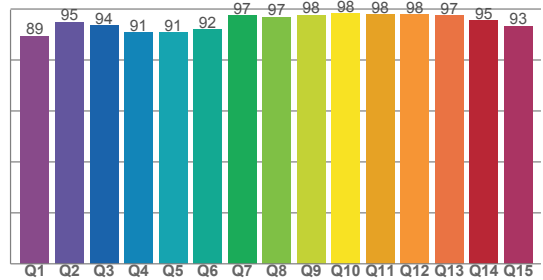

Color parameters

Color temperature	Color rendering index	Red component	Color fidelity	Color gamut	Color quality scale	Color coordinate cie 1931	Color coordinate cie 1931	Color coordinate	Color coordinate	Color deviation from black body
CCT	CRI	CRI R9	TM30 Rf	TM30 Rg	CQS	x	y	u	v	Δuv
2991 K	97.2	95.1	90.6	98.1	93.8	0.436	0.401	0.251	0.347	-0.0011

Note: specifications are representative of the diode type and not a particular tape light article.

3000K

Rf 90.6
Fidelity index Rf

Rg 98.1
Gammut index Rg

Hue Bin	R _f	Graphic shifts (%)	
		Chroma	Hue
1	92	-1%	2%
2	96	0%	0%
3	96	0%	-1%
4	90	-5%	-4%
5	90	-8%	-1%
6	94	-3%	1%
7	85	-6%	6%
8	92	-2%	4%
9	87	0%	8%
10	85	3%	9%
11	88	5%	7%
12	91	5%	-1%
13	93	0%	-5%
14	92	2%	-5%
15	89	-2%	-1%
16	89	1%	-7%

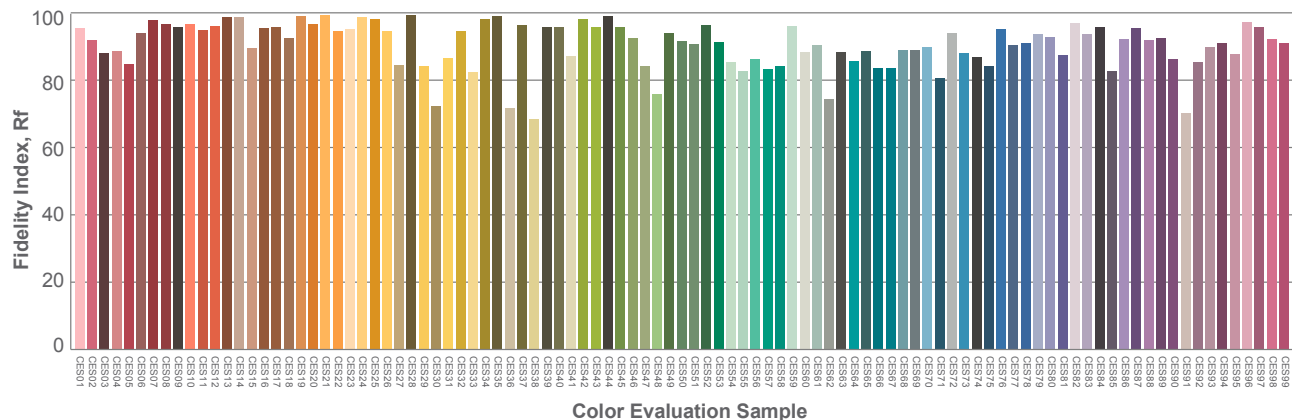
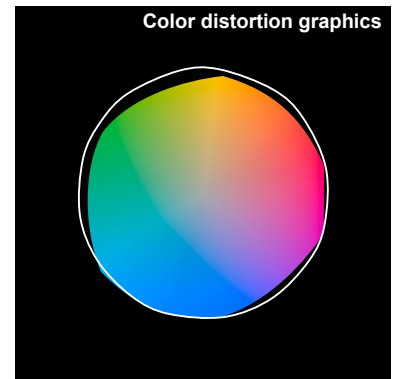
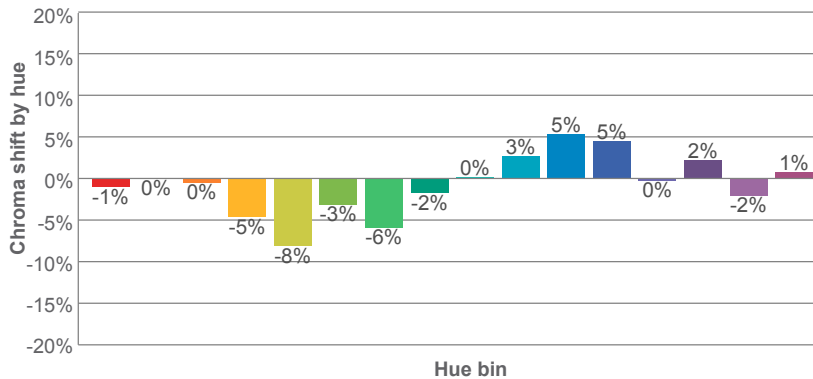
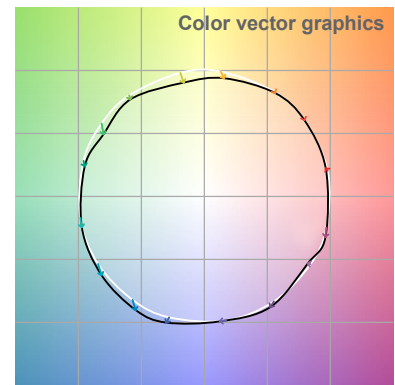
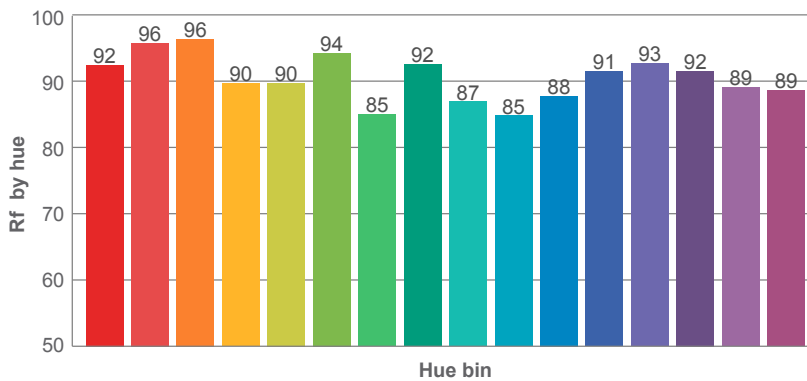
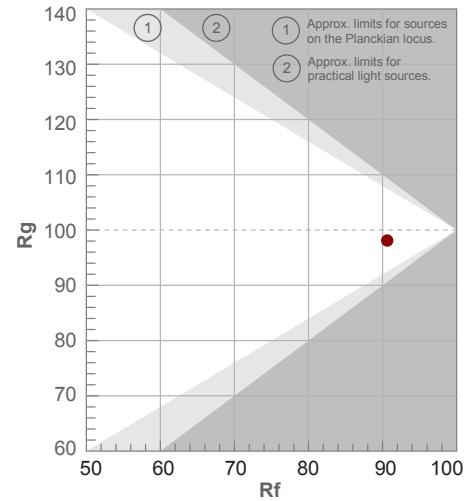

Note: specifications are representative of the diode type and not a particular tape light article.

3000K

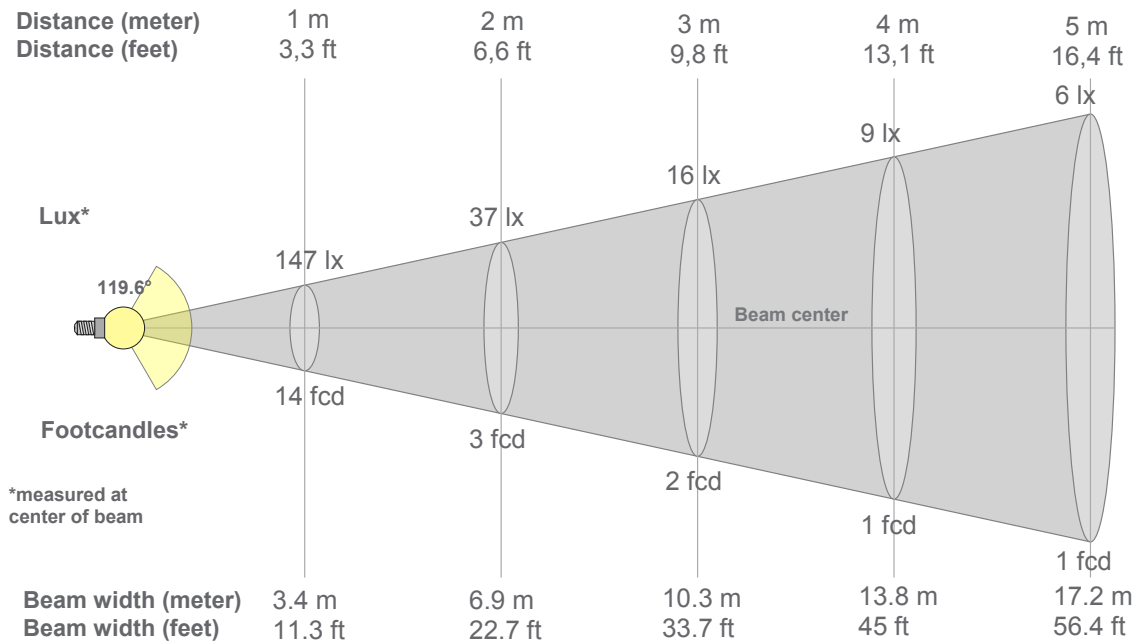

Beam intensities from 1-20m

1m	2m	3m	4m	5m	6m	7m	8m	9m	10m	11m	12m	13m	14m	15m	16m	17m	18m	19m	20m
3.3ft	6.6ft	9.8ft	13.1ft	16.4ft	19.7ft	23ft	26.2ft	29.5ft	32.8ft	36.1ft	39.4ft	42.7ft	45.9ft	49.2ft	52.5ft	55.8ft	59.1ft	62.3ft	65.6ft
147lx	37lx	16lx	9lx	6lx	4lx	3lx	2lx	2lx	1lx	1lx	1lx	1lx	1lx	1lx	1lx	1lx	0lx	0lx	0lx
13.6fcd	3.4fcd	1.5fcd	0.9fcd	0.5fcd	0.4fcd	0.3fcd	0.2fcd	0.2fcd	0.1fcd	0.1fcd	0.1fcd	0.1fcd	0.1fcd	0.1fcd	0.1fcd	0fcd	0fcd	0fcd	0fcd

Intensities in 0° c-plane

0°	5°	10°	15°	20°	25°	30°	35°	40°	45°	50°	55°	60°	65°	70°	75°	80°	85°	90°	95°
147	146	144	141	137	132	126	120	112	103	94	84	73	61	49	36	23	12	4	1
100%	99%	98%	96%	94%	90%	86%	82%	76%	71%	64%	57%	50%	42%	33%	24%	16%	8%	2%	1%

Intensities in 90° c-plane

0°	5°	10°	15°	20°	25°	30°	35°	40°	45°	50°	55°	60°	65°	70°	75°	80°	85°	90°	95°
147	146	144	141	137	132	126	120	112	103	94	84	73	61	49	36	23	12	4	1
100%	99%	98%	96%	94%	90%	86%	82%	76%	71%	64%	57%	50%	42%	33%	24%	16%	8%	2%	1%

Intensities in 180° c-plane

0°	5°	10°	15°	20°	25°	30°	35°	40°	45°	50°	55°	60°	65°	70°	75°	80°	85°	90°	95°
147	146	145	142	138	134	128	121	113	104	94	84	73	61	49	36	24	13	4	1
100%	100%	99%	97%	94%	91%	87%	82%	77%	71%	64%	57%	50%	42%	33%	25%	16%	9%	2%	1%

Intensities in 270° c-plane

0°	5°	10°	15°	20°	25°	30°	35°	40°	45°	50°	55°	60°	65°	70°	75°	80°	85°	90°	95°
147	146	145	142	138	134	128	121	113	104	94	84	73	61	49	36	24	13	4	1
100%	100%	99%	97%	94%	91%	87%	82%	77%	71%	64%	57%	50%	42%	33%	25%	16%	9%	2%	1%

Beam angle 50%	Field angle 10%	Cutoff angle 2,5%	Intensity ratio in 120° cone	Intensity ratio in 90° cone
119.6°	167.9°	179.9°	74.2%	49.5%

Note: specifications are representative of the diode type and not a particular tape light article.

3500K

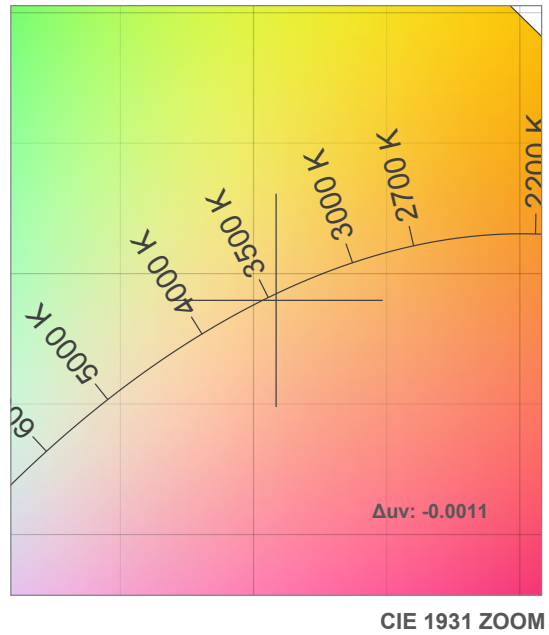
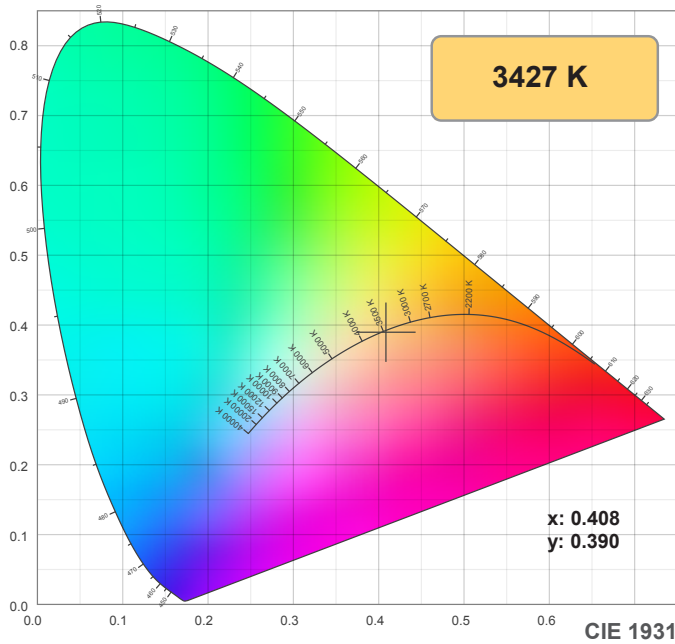

TM30: 92.3

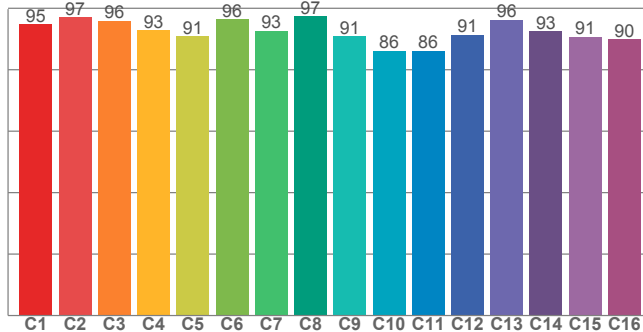

CRI: 98.0 (R1-R8)

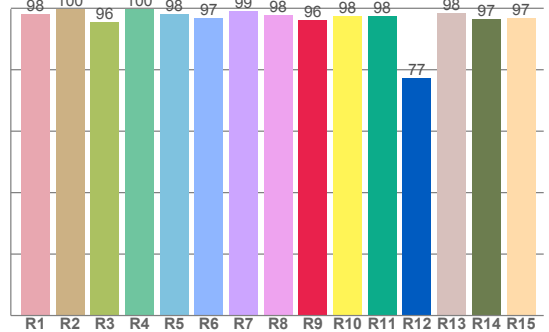

CRI R values, only R1-R8 are used to calculate final CRI value

R1	R2	R3	R4	R5	R6	R7	R8	R9	R10	R11	R12	R13	R14	R15
98.0	99.7	95.6	99.6	98.1	96.8	99.0	97.6	96.2	97.5	97.5	77.4	98.4	96.6	96.7

TM30 C values, 16 binned values out of total of 99 C values

C1	C2	C3	C4	C5	C6	C7	C8	C9	C10	C11	C12	C13	C14	C15	C16
94.7	97.1	95.9	92.9	91.0	96.4	92.7	97.4	90.8	86.2	86.2	91.3	96.3	92.5	90.7	90.0

CQS Q values

Q1	Q2	Q3	Q4	Q5	Q6	Q7	Q8	Q9	Q10	Q11	Q12	Q13	Q14	Q15
93.8	98.7	90.4	90.3	94.1	97.4	96.2	98.2	97.2	97.5	98.1	99.5	99.1	97.8	96.3

CQS: 95.3

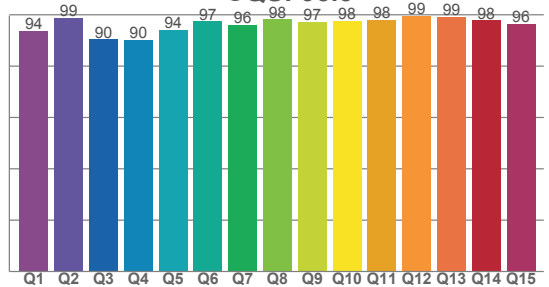

Color parameters

Color temperature	Color rendering index	Red component	Color fidelity	Color gamut	Color quality scale	Color coordinate cie 1931	Color coordinate cie 1931	Color coordinate	Color coordinate	Color deviation from black body
CCT	CRI	CRI R9	TM30 Rf	TM30 Rg	CQS	x	y	u	v	Δuv
3427 K	98.0	96.2	92.3	100.5	95.3	0.408	0.390	0.238	0.341	-0.0011

Note: specifications are representative of the diode type and not a particular tape light article.

3500K

Rf 92.3
Fidelity index Rf

Rg 100.5
Gammut index Rg

Hue Bin	R _f	Graphic shifts (%)	
		Chroma	Hue
1	95	0%	1%
2	97	0%	-1%
3	96	0%	0%
4	93	-3%	-1%
5	91	-6%	0%
6	96	0%	1%
7	93	-3%	3%
8	97	-1%	1%
9	91	0%	6%
10	86	1%	9%
11	86	4%	8%
12	91	4%	2%
13	96	1%	-1%
14	93	5%	-2%
15	91	2%	-1%
16	90	2%	-4%

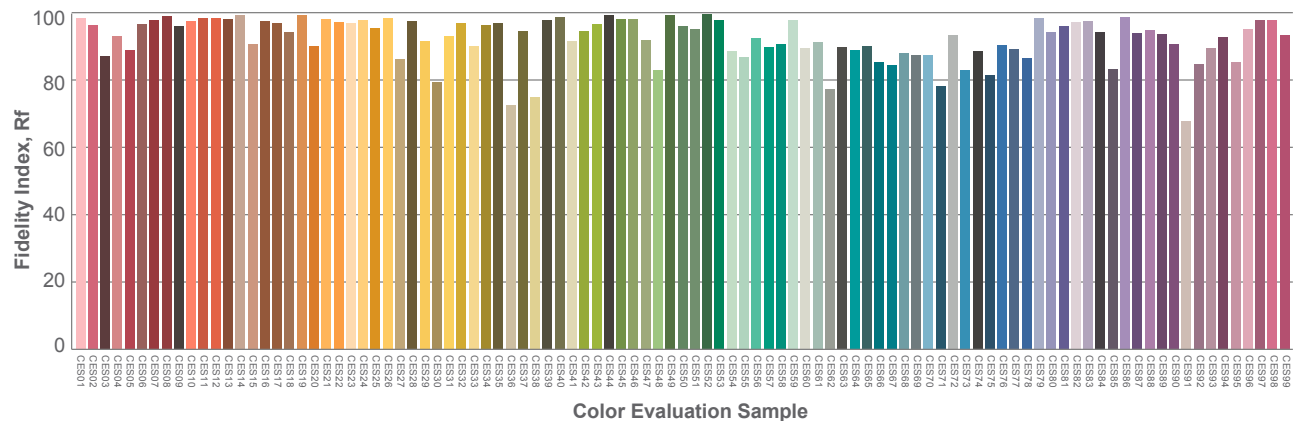
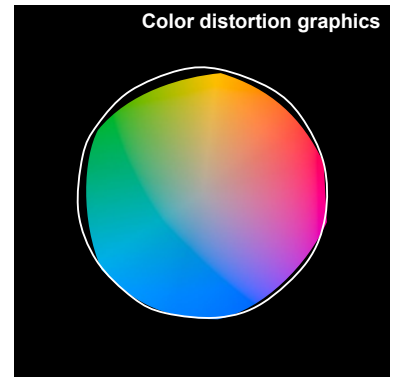
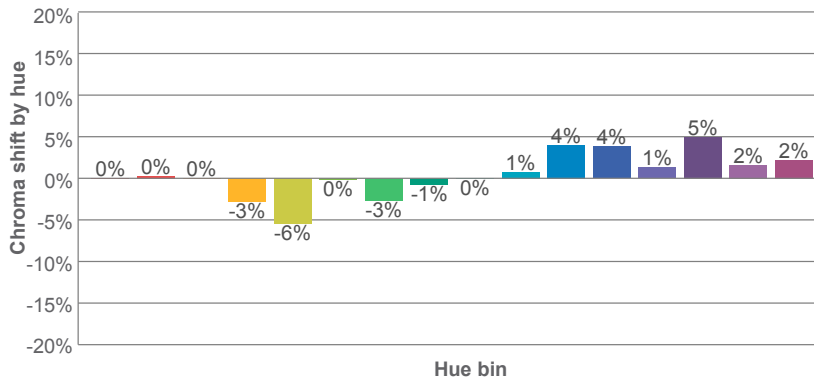
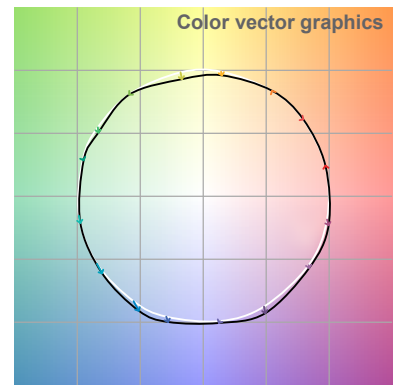
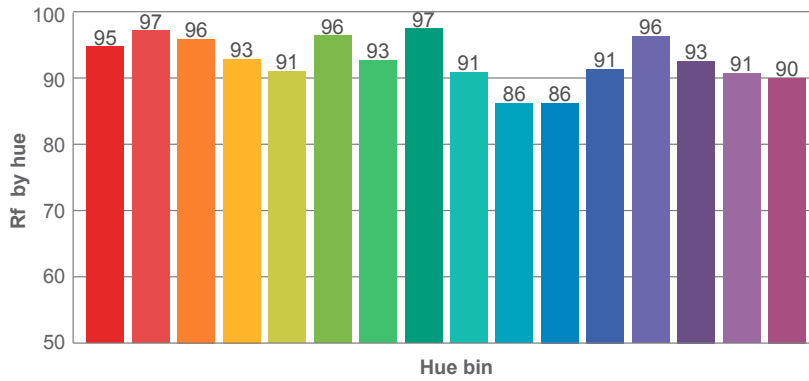
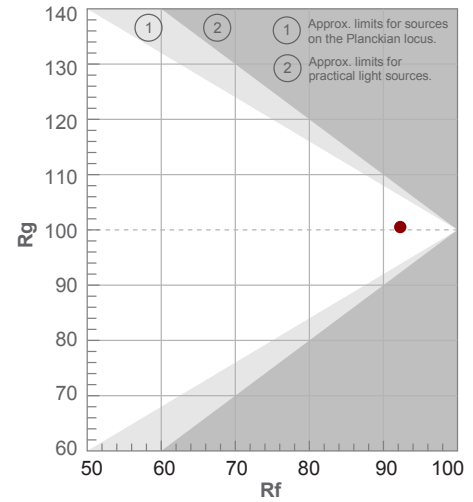

Note: specifications are representative of the diode type and not a particular tape light article.

3500K

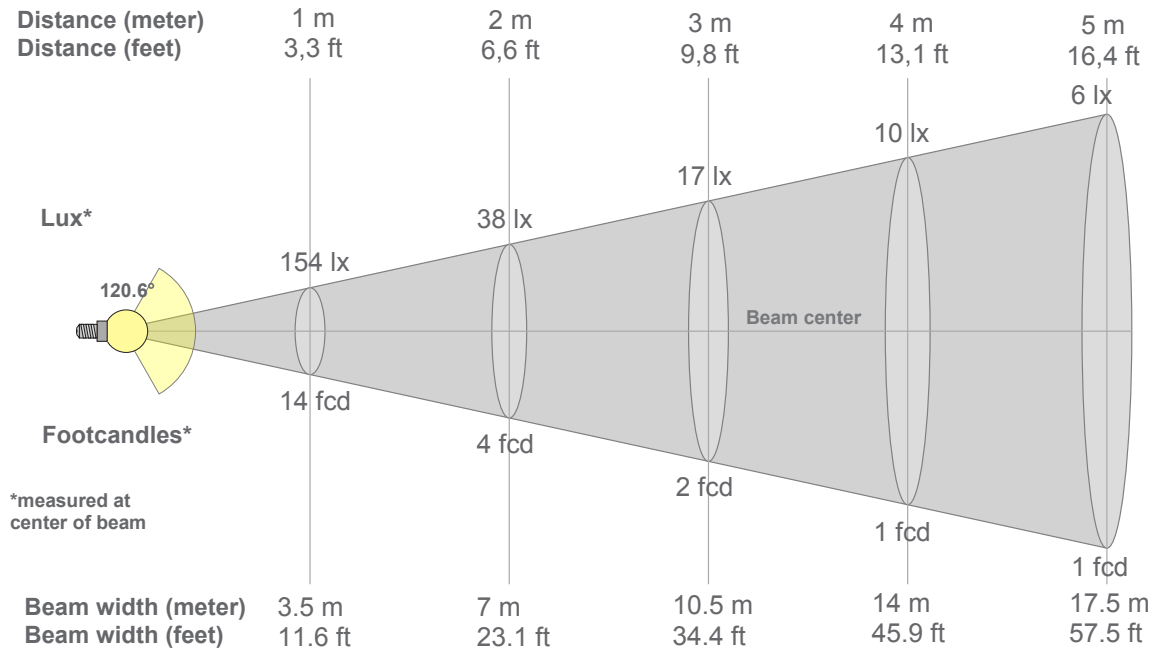

Beam intensities from 1-20m

1m	2m	3m	4m	5m	6m	7m	8m	9m	10m	11m	12m	13m	14m	15m	16m	17m	18m	19m	20m
3.3ft	6.6ft	9.8ft	13.1ft	16.4ft	19.7ft	23ft	26.2ft	29.5ft	32.8ft	36.1ft	39.4ft	42.7ft	45.9ft	49.2ft	52.5ft	55.8ft	59.1ft	62.3ft	65.6ft
154lx	38lx	17lx	10lx	6lx	4lx	3lx	2lx	2lx	2lx	1lx	1lx	1lx	1lx	1lx	1lx	1lx	0lx	0lx	0lx
14.3fcd	3.6fcd	1.6fcd	0.9fcd	0.6fcd	0.4fcd	0.3fcd	0.2fcd	0.2fcd	0.1fcd	0.1fcd	0.1fcd	0.1fcd	0.1fcd	0.1fcd	0.1fcd	0fcd	0fcd	0fcd	0fcd

Intensities in 0° c-plane

0°	5°	10°	15°	20°	25°	30°	35°	40°	45°	50°	55°	60°	65°	70°	75°	80°	85°	90°	95°
154	153	151	148	144	139	133	126	118	110	100	89	78	65	52	39	25	13	4	1
100%	99%	98%	96%	94%	91%	87%	82%	77%	71%	65%	58%	50%	42%	34%	25%	16%	9%	3%	1%

Intensities in 90° c-plane

0°	5°	10°	15°	20°	25°	30°	35°	40°	45°	50°	55°	60°	65°	70°	75°	80°	85°	90°	95°
154	153	151	148	144	139	133	126	118	110	100	89	78	65	52	39	25	13	4	1
100%	99%	98%	96%	94%	91%	87%	82%	77%	71%	65%	58%	50%	42%	34%	25%	16%	9%	3%	1%

Intensities in 180° c-plane

0°	5°	10°	15°	20°	25°	30°	35°	40°	45°	50°	55°	60°	65°	70°	75°	80°	85°	90°	95°
154	153	152	149	145	140	134	127	119	110	100	89	78	65	52	38	25	13	4	1
100%	100%	99%	97%	95%	91%	88%	83%	78%	72%	65%	58%	50%	42%	34%	25%	16%	8%	2%	1%

Intensities in 270° c-plane

0°	5°	10°	15°	20°	25°	30°	35°	40°	45°	50°	55°	60°	65°	70°	75°	80°	85°	90°	95°
154	153	152	149	145	140	134	127	119	110	100	89	78	65	52	38	25	13	4	1
100%	100%	99%	97%	95%	91%	88%	83%	78%	72%	65%	58%	50%	42%	34%	25%	16%	8%	2%	1%

Beam angle 50%	Field angle 10%	Cutoff angle 2,5%	Intensity ratio in 120° cone	Intensity ratio in 90° cone
120.6°	167.9°	180.3°	74.2%	49.4%

Note: specifications are representative of the diode type and not a particular tape light article.

4200K

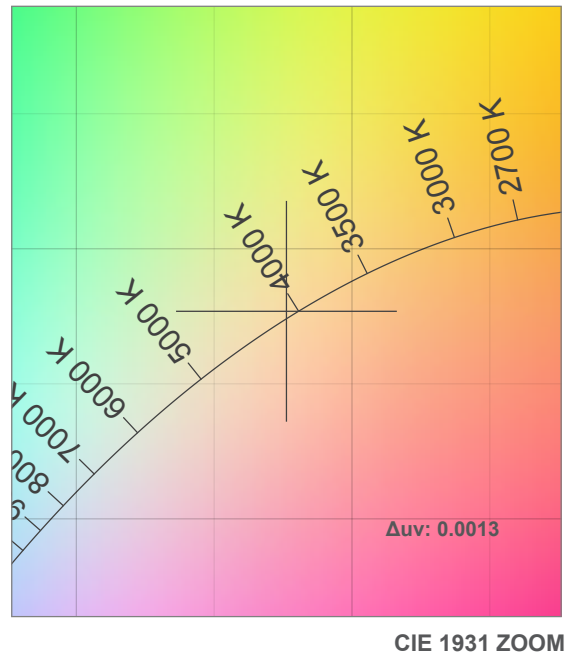
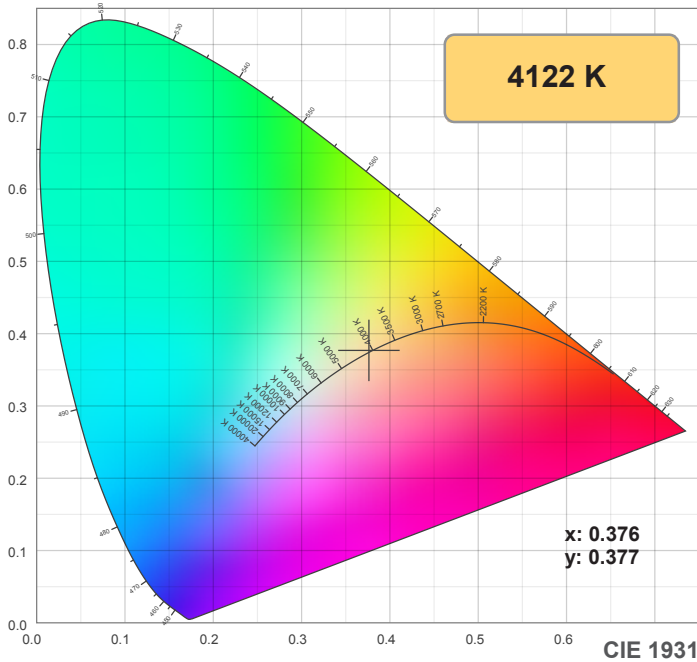

TM30: 91.1

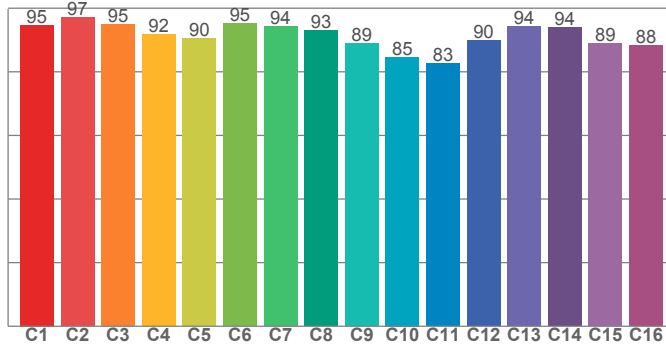

CRI: 96.6 (R1-R8)

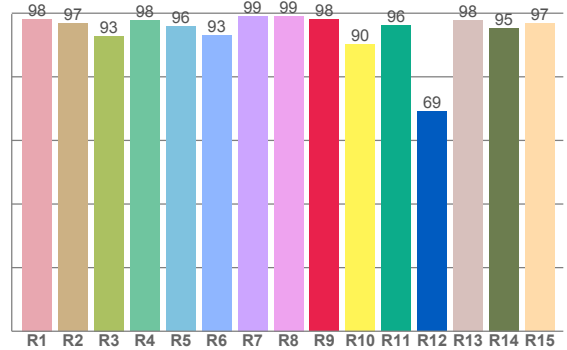

CRI R values, only R1-R8 are used to calculate final CRI value

R1	R2	R3	R4	R5	R6	R7	R8	R9	R10	R11	R12	R13	R14	R15
98.2	96.8	92.8	97.8	95.8	93.1	99.1	99.1	98.0	90.3	96.1	69.1	97.9	95.4	96.8

TM30 C values, 16 binned values out of total of 99 C values

C1	C2	C3	C4	C5	C6	C7	C8	C9	C10	C11	C12	C13	C14	C15	C16
94.7	97.1	94.9	91.8	90.5	95.3	94.2	92.9	88.9	84.6	82.5	89.9	94.2	93.9	88.8	88.3

CQS Q values

Q1	Q2	Q3	Q4	Q5	Q6	Q7	Q8	Q9	Q10	Q11	Q12	Q13	Q14	Q15
94.8	99.5	87.2	87.0	92.2	94.9	95.3	98.1	96.4	96.1	96.9	98.4	98.8	99.5	97.9

CQS: 94.1

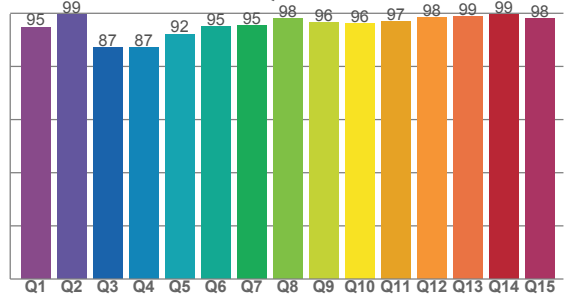

Color parameters

Color temperature	Color rendering index	Red component	Color fidelity	Color gamut	Color quality scale	Color coordinate cie 1931	Color coordinate cie 1931	Color coordinate	Color coordinate	Color deviation from black body
CCT	CRI	CRI R9	TM30 Rf	TM30 Rg	CQS	x	y	u	v	Δuv
4122 K	96.6	98.0	91.1	100.1	94.1	0.376	0.377	0.222	0.334	0.0013

Note: specifications are representative of the diode type and not a particular tape light article.

4200K

Rf 91.1
Fidelity index Rf

Rg 100.1
Gammut index Rg

Hue Bin	R _f	Graphic shifts (%)	
		Chroma	Hue
1	95	-1%	0%
2	97	0%	0%
3	95	-1%	1%
4	92	-3%	0%
5	90	-4%	1%
6	95	-1%	1%
7	94	-3%	1%
8	93	-2%	3%
9	89	-2%	7%
10	85	-1%	9%
11	83	3%	10%
12	90	3%	4%
13	94	4%	1%
14	94	2%	0%
15	89	4%	-4%
16	88	3%	-6%

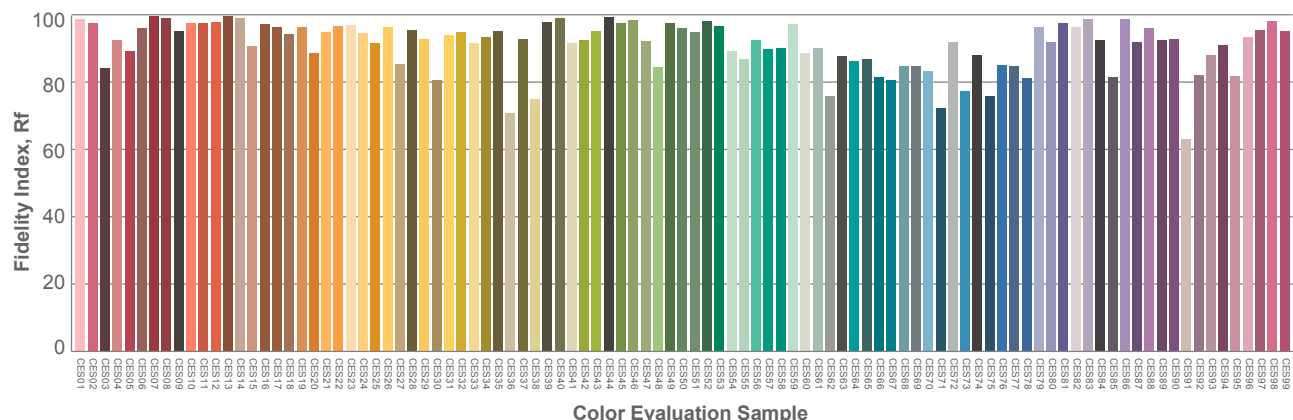
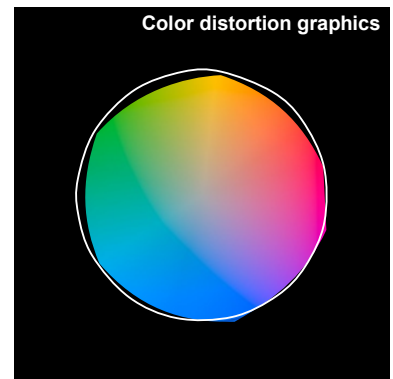
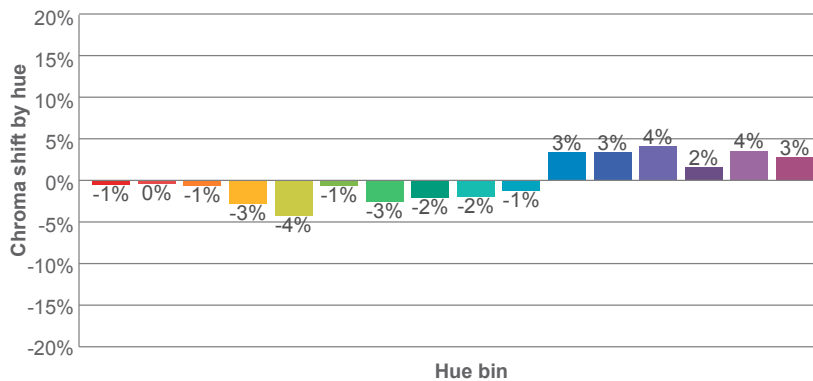
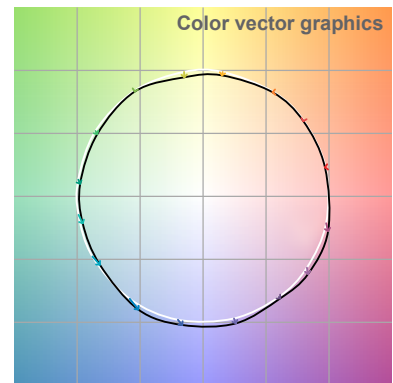
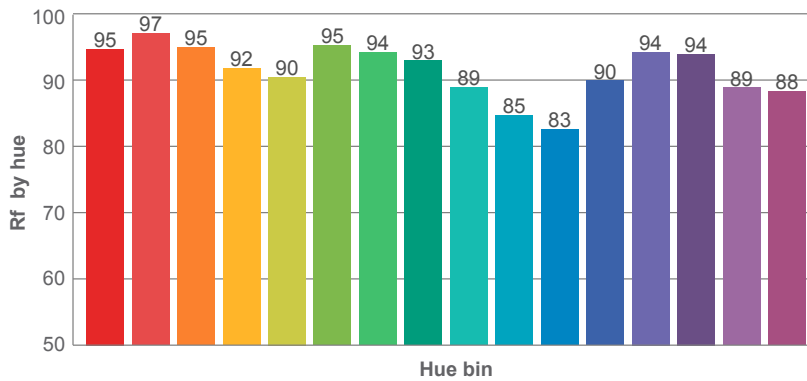
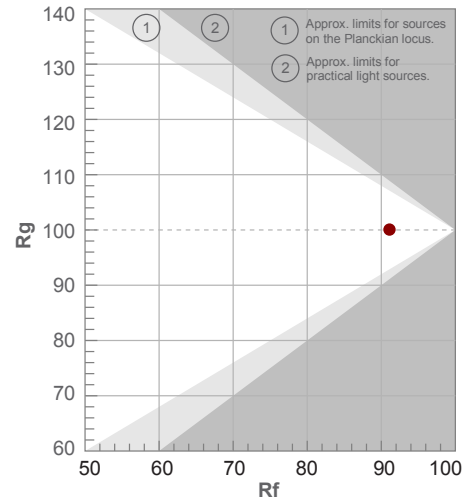

Note: specifications are representative of the diode type and not a particular tape light article.

4200K

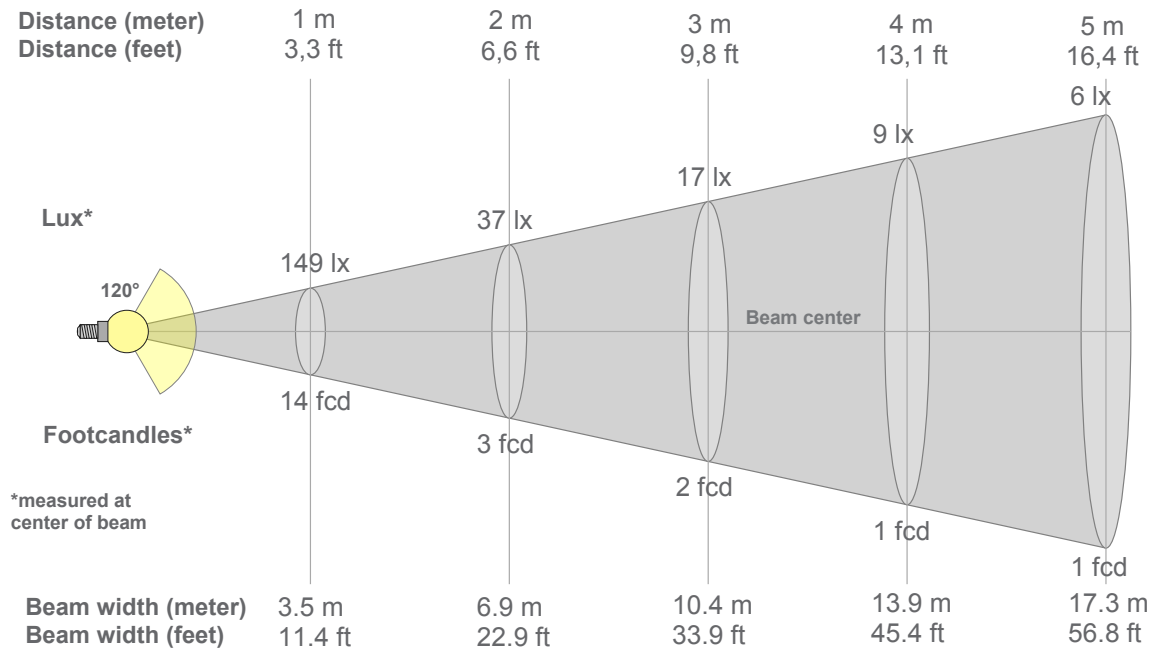

Beam intensities from 1-20m

1m	2m	3m	4m	5m	6m	7m	8m	9m	10m	11m	12m	13m	14m	15m	16m	17m	18m	19m	20m
3.3ft	6.6ft	9.8ft	13.1ft	16.4ft	19.7ft	23ft	26.2ft	29.5ft	32.8ft	36.1ft	39.4ft	42.7ft	45.9ft	49.2ft	52.5ft	55.8ft	59.1ft	62.3ft	65.6ft
149lx	37lx	17lx	9lx	6lx	4lx	3lx	2lx	2lx	1lx	1lx	1lx	1lx	1lx	1lx	1lx	1lx	0lx	0lx	0lx
13.9fcd	3.5fcd	1.5fcd	0.9fcd	0.6fcd	0.4fcd	0.3fcd	0.2fcd	0.2fcd	0.1fcd	0.1fcd	0.1fcd	0.1fcd	0.1fcd	0.1fcd	0.1fcd	0fcd	0fcd	0fcd	0fcd

Intensities in 0° c-plane

0°	5°	10°	15°	20°	25°	30°	35°	40°	45°	50°	55°	60°	65°	70°	75°	80°	85°	90°	95°
149	149	147	144	140	135	129	122	114	106	96	86	75	63	50	37	24	12	4	1
100%	99%	98%	96%	94%	90%	86%	82%	76%	71%	64%	58%	50%	42%	33%	25%	16%	8%	3%	1%

Intensities in 90° c-plane

0°	5°	10°	15°	20°	25°	30°	35°	40°	45°	50°	55°	60°	65°	70°	75°	80°	85°	90°	95°
149	149	147	144	140	135	129	122	114	106	96	86	75	63	50	37	24	12	4	1
100%	99%	98%	96%	94%	90%	86%	82%	76%	71%	64%	58%	50%	42%	33%	25%	16%	8%	3%	1%

Intensities in 180° c-plane

0°	5°	10°	15°	20°	25°	30°	35°	40°	45°	50°	55°	60°	65°	70°	75°	80°	85°	90°	95°
149	149	148	145	141	136	130	123	115	106	96	86	75	63	51	38	26	14	5	1
100%	100%	99%	97%	95%	91%	87%	82%	77%	71%	64%	58%	50%	42%	34%	25%	17%	9%	3%	1%

Intensities in 270° c-plane

0°	5°	10°	15°	20°	25°	30°	35°	40°	45°	50°	55°	60°	65°	70°	75°	80°	85°	90°	95°
149	149	148	145	141	136	130	123	115	106	96	86	75	63	51	38	26	14	5	1
100%	100%	99%	97%	95%	91%	87%	82%	77%	71%	64%	58%	50%	42%	34%	25%	17%	9%	3%	1%

Beam angle 50%	Field angle 10%	Cutoff angle 2,5%	Intensity ratio in 120° cone	Intensity ratio in 90° cone
120°	168.3°	181.4°	74.0%	49.3%

Note: specifications are representative of the diode type and not a particular tape light article.

5000K

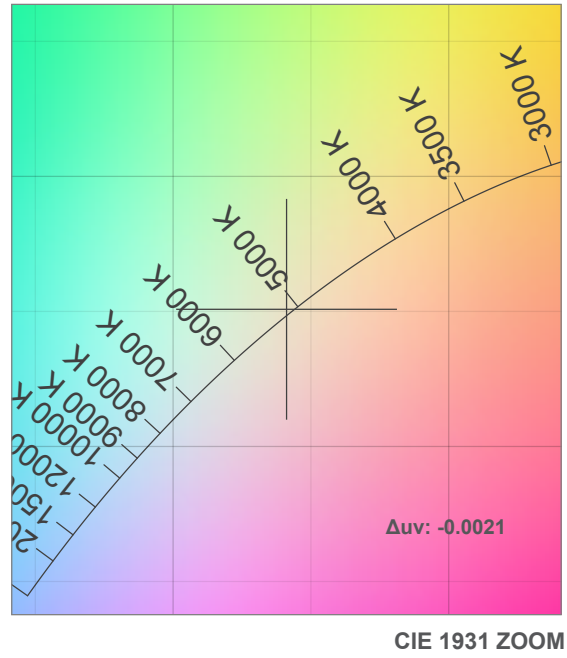
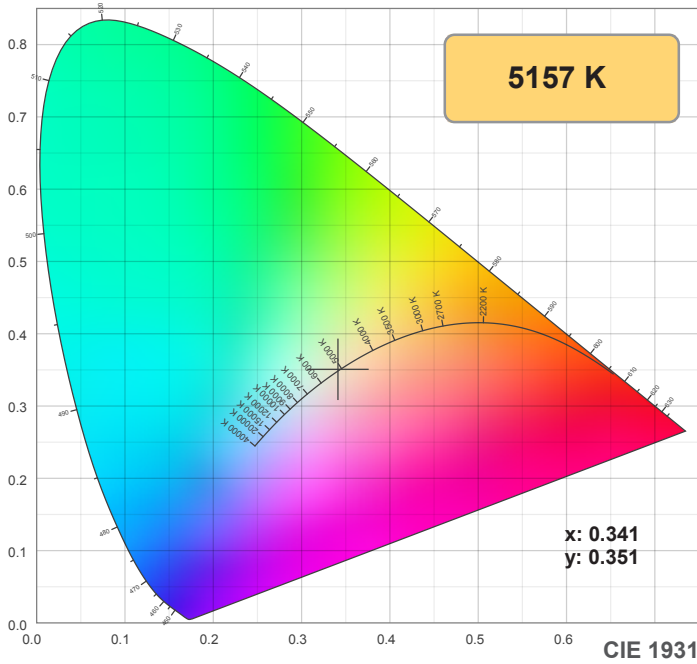

TM30: 89.9

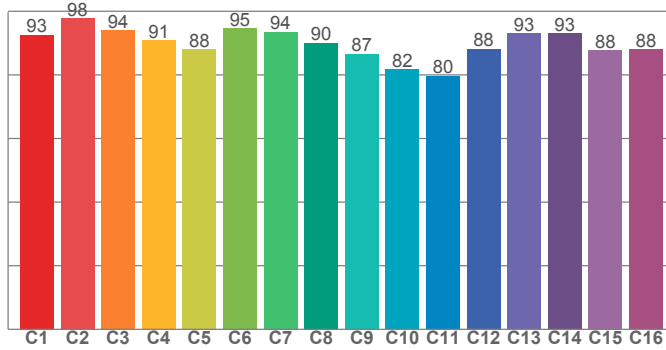

CRI: 96.1 (R1-R8)

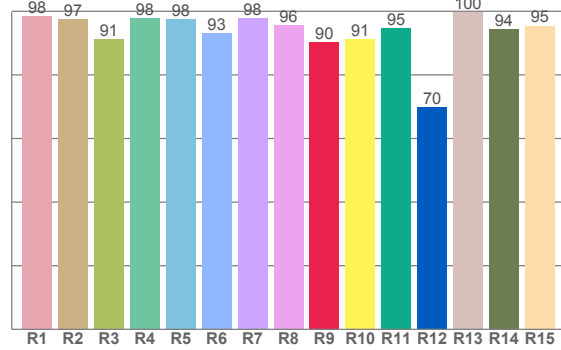

CRI R values, only R1-R8 are used to calculate final CRI value

R1	R2	R3	R4	R5	R6	R7	R8	R9	R10	R11	R12	R13	R14	R15
98.4	97.5	91.1	97.7	97.5	93.0	97.7	95.6	90.2	91.3	94.8	69.9	99.7	94.5	95.5

TM30 C values, 16 binned values out of total of 99 C values

C1	C2	C3	C4	C5	C6	C7	C8	C9	C10	C11	C12	C13	C14	C15	C16
92.5	97.8	93.9	90.8	88.1	94.7	93.5	90.0	86.7	81.7	79.7	88.2	93.0	93.1	87.7	87.9

CQS Q values

Q1	Q2	Q3	Q4	Q5	Q6	Q7	Q8	Q9	Q10	Q11	Q12	Q13	Q14	Q15
96.4	98.5	84.6	85.3	92.2	95.9	95.0	98.8	94.3	94.0	95.2	98.0	99.6	98.8	97.8

CQS: 93.3

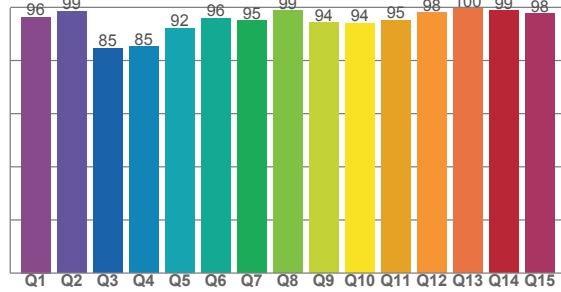

Color parameters

Color temperature	Color rendering index	Red component	Color fidelity	Color gamut	Color quality scale	Color coordinate cie 1931	Color coordinate cie 1931	Color coordinate	Color coordinate	Color deviation from black body
CCT	CRI	CRI R9	TM30 Rf	TM30 Rg	CQS	x	y	u	v	Δuv
5157 K	96.1	90.2	89.9	100.6	93.3	0.341	0.351	0.209	0.322	-0.0021

Note: specifications are representative of the diode type and not a particular tape light article.

5000K

Rf 89.9
Fidelity index Rf

Rg 100.6
Gammut index Rg

Hue Bin	R _f	Graphic shifts (%)	
		Chroma	Hue
1	93	1%	0%
2	98	1%	0%
3	94	0%	-1%
4	91	-3%	-1%
5	88	-5%	0%
6	95	-1%	1%
7	94	-3%	1%
8	90	-3%	4%
9	87	-3%	10%
10	82	-1%	10%
11	80	4%	12%
12	88	4%	5%
13	93	4%	3%
14	93	2%	0%
15	88	5%	-2%
16	88	4%	-5%

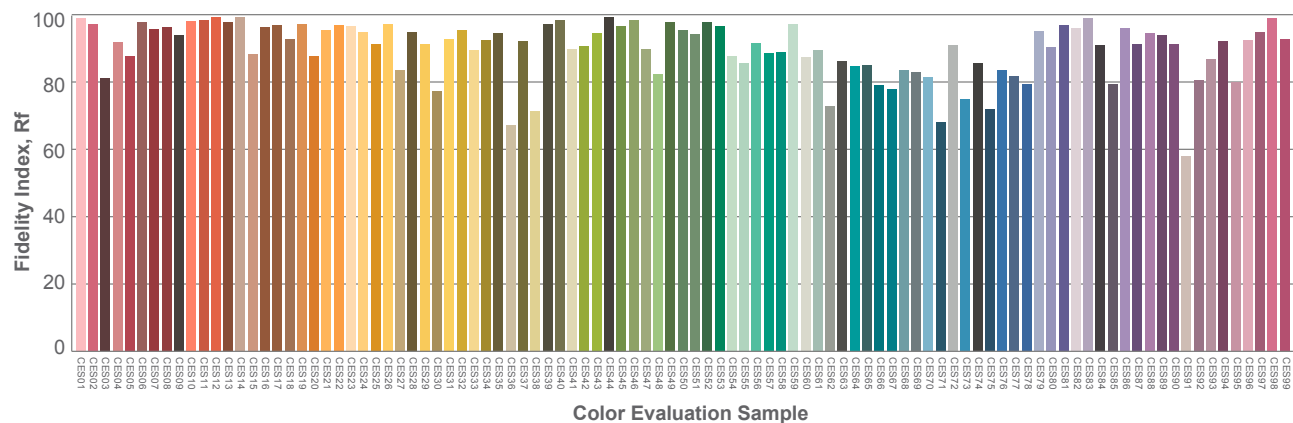
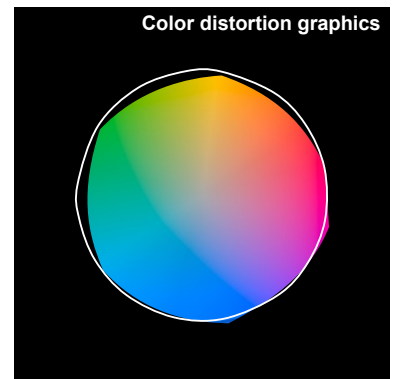
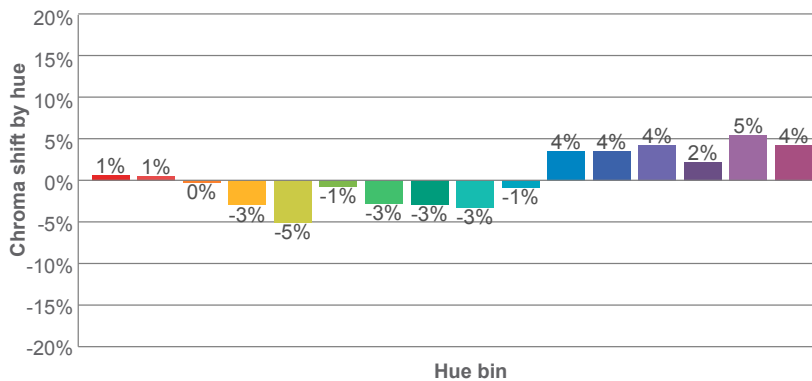
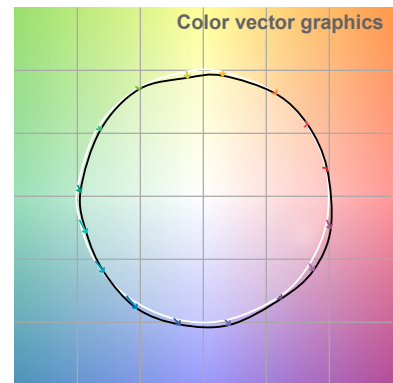
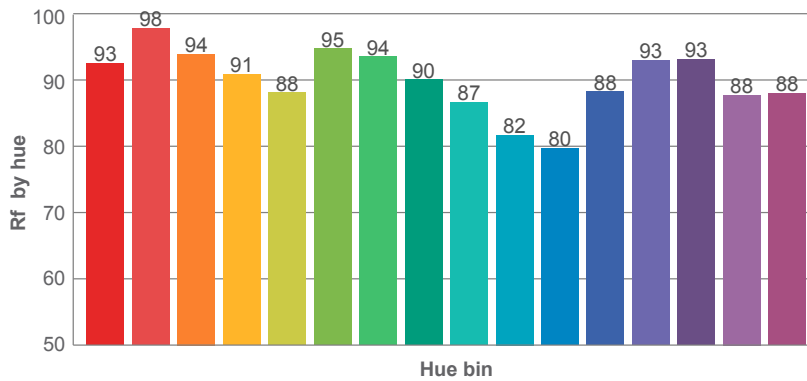
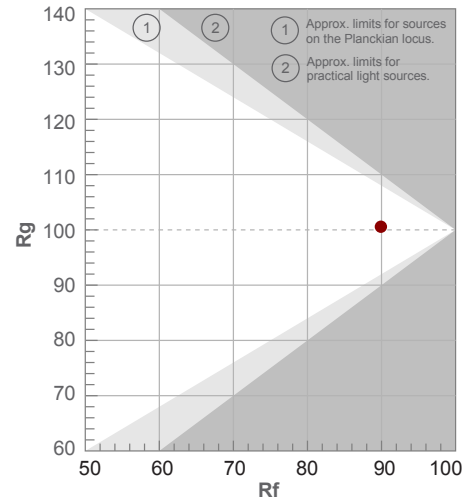

Note: specifications are representative of the diode type and not a particular tape light article.

5000K

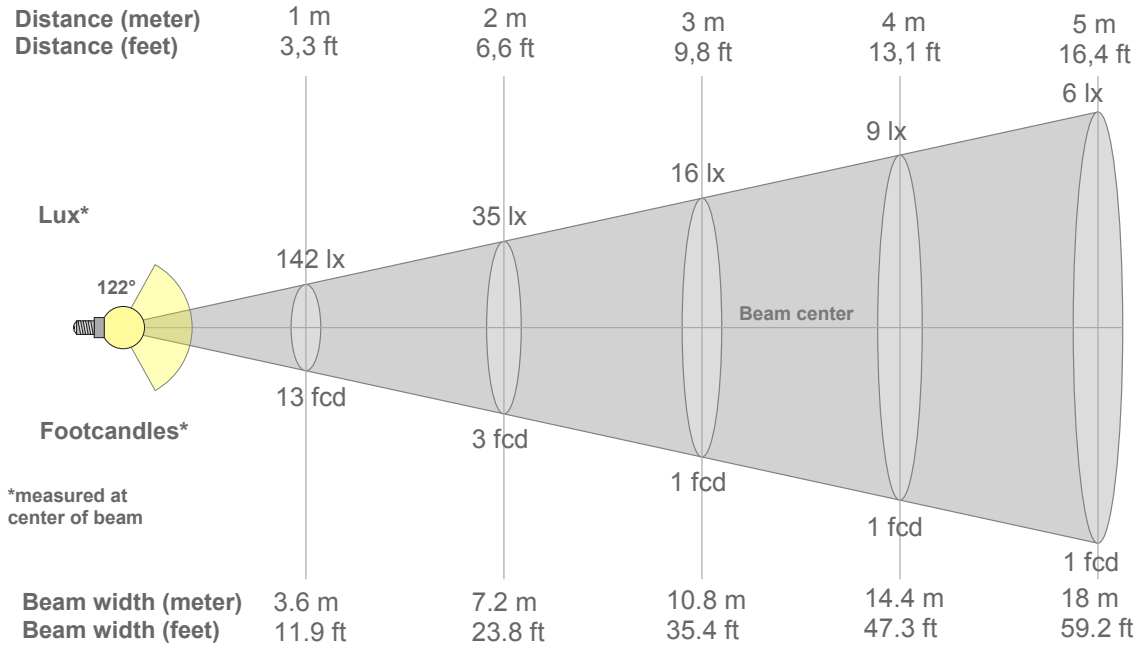

Beam intensities from 1-20m

1m	2m	3m	4m	5m	6m	7m	8m	9m	10m	11m	12m	13m	14m	15m	16m	17m	18m	19m	20m
3.3ft	6.6ft	9.8ft	13.1ft	16.4ft	19.7ft	23ft	26.2ft	29.5ft	32.8ft	36.1ft	39.4ft	42.7ft	45.9ft	49.2ft	52.5ft	55.8ft	59.1ft	62.3ft	65.6ft
142lx	35lx	16lx	9lx	6lx	4lx	3lx	2lx	2lx	1lx	1lx	1lx	1lx	1lx	1lx	1lx	0lx	0lx	0lx	0lx
13.2fcd	3.3fcd	1.5fcd	0.8fcd	0.5fcd	0.4fcd	0.3fcd	0.2fcd	0.2fcd	0.1fcd	0.1fcd	0.1fcd	0.1fcd	0.1fcd	0.1fcd	0.1fcd	0fcd	0fcd	0fcd	0fcd

Intensities in 0° c-plane

0°	5°	10°	15°	20°	25°	30°	35°	40°	45°	50°	55°	60°	65°	70°	75°	80°	85°	90°	95°
142	141	140	137	134	130	125	118	111	103	94	84	73	62	50	37	25	13	5	1
100%	100%	99%	97%	95%	91%	88%	83%	78%	72%	66%	59%	52%	44%	35%	26%	17%	9%	3%	1%

Intensities in 90° c-plane

0°	5°	10°	15°	20°	25°	30°	35°	40°	45°	50°	55°	60°	65°	70°	75°	80°	85°	90°	95°
142	141	140	137	134	130	125	118	111	103	94	84	73	62	50	37	25	13	5	1
100%	100%	99%	97%	95%	91%	88%	83%	78%	72%	66%	59%	52%	44%	35%	26%	17%	9%	3%	1%

Intensities in 180° c-plane

0°	5°	10°	15°	20°	25°	30°	35°	40°	45°	50°	55°	60°	65°	70°	75°	80°	85°	90°	95°
142	142	140	138	134	130	125	118	111	103	94	84	73	62	49	36	23	12	3	1
100%	100%	99%	97%	95%	92%	88%	83%	78%	73%	66%	59%	52%	43%	35%	26%	17%	8%	2%	1%

Intensities in 270° c-plane

0°	5°	10°	15°	20°	25°	30°	35°	40°	45°	50°	55°	60°	65°	70°	75°	80°	85°	90°	95°
142	142	140	138	134	130	125	118	111	103	94	84	73	62	49	36	23	12	3	1
100%	100%	99%	97%	95%	92%	88%	83%	78%	73%	66%	59%	52%	43%	35%	26%	17%	8%	2%	1%

Beam angle 50%	Field angle 10%	Cutoff angle 2,5%	Intensity ratio in 120° cone	Intensity ratio in 90° cone
122°	168.5°	180.8°	73.8%	48.9%