

PrimaLine® 3 Wet Location LED Tape Light



Actual size shown

Field cuttable every 1 in. (12V) / 2 in. (24V)

0.4 in. wide



PrimaLine 3 Wet Location Tape Light offers high-output, dimmable task lighting at just 3 watts per foot and is safe for use in wet locations. This tape light is perfect for medium to large task lighting, accenting, and workspace lighting, as well as kitchen, bathroom, cabinet, and shelf applications.

- Medium to large task, accent, and workspace lighting
- Use in kitchens, bathrooms, cabinets, and shelves
- Perfect for wet or dusty locations and high traffic locations indoors and outdoors

TECHNICAL INFORMATION

Color Temperature	2700K, 3000K, 4200K, 5000K*	Diode Type	3528 SMD
12V Power Consumption per Foot	2.88 Watts/240mA	Mounting	3M™ Self-Adhesive Tape (Acrylic Foam), Mounting Clips (Included)
24V Power Consumption per Foot	2.88 Watts/120mA	Operating Temperature	-13° F to 140° F
Input Voltage	12/24V DC	Ambient Temperature	-40° F to 186° F
Diodes per foot	36	Spool Length**	16.4 ft., 20 ft.
Diode Spacing	0.3 inches	Environment	Indoor/Outdoor, Dry/Wet, IP68
Tape Height	0.2 inches	Certifications	UL Listed, UL 2108, CE, RoHS
Beam Angle	120°	Standards	Certified to the CA Energy Commission in accordance with the Title 24 JA8 2016 std.
12V Field Cuttable (UL 2108)	Every 1 inch	Warranty	6 Year Limited
24V Field Cuttable (UL 2108)	Every 2 inches		
Max Run Length	21 ft. (12V), 33 ft. (24V)		
Dimmable	Yes		

* In addition to stocked colors, a wide variety of Color Temperatures is also available by special order. Please call or email to order.

**Each spool includes 3 ft., 20 AWG lead wires at both ends of the tape light.

PRODUCT INFORMATION

16.4 ft. Spool	20 ft. Spool	Color Temperature	Watts per Foot	CRI	R9 Value	R13 Value	TM30	CQS	Lumens per Foot
AL-01-02-1261	AL-01-02-2461	● 2700K	2.88W	97.2	86.5	97.5	94	92.4	185
AL-01-02-1262	AL-01-02-2462	● 3000K	2.88W	95.1	76.8	94.5	90.4	91.6	205
AL-01-02-1263	AL-01-02-2463	○ 4200K	2.88W	94.2	86.9	96	90.3	93.2	193
AL-01-02-1264	AL-01-02-2464	● 5000K	2.88W	94.1	82.1	94.7	89.6	92.7	264

12V DC: Max run is 21'

24V DC: Max run is 33'

VOLTAGE DROP GUIDANCE CHART

Standard Non-XT 12V Voltage Drop and Wire Length Distance Chart (3% Drop or 11V)

Wire Gauge	Copper Wire Resistance (Ω/kFT)	10W (0.83A)	20W (1.67A)	30W (2.50A)	40W (3.33A)	50W (4.17A)	60W (5A)
22 AWG	16.14	14 ft.	7 ft.	5 ft.	4 ft.	3 ft.	3 ft.
20 AWG	10.15	22 ft.	11 ft.	8 ft.	6 ft.	5 ft.	4 ft.
18 AWG	6.39	34 ft.	17 ft.	12 ft.	9 ft.	7 ft.	6 ft.
16 AWG	4.02	54 ft.	27 ft.	18 ft.	14 ft.	11 ft.	9 ft.
14 AWG	2.53	86 ft.	43 ft.	29 ft.	22 ft.	18 ft.	15 ft.
12 AWG	1.59	137 ft.	69 ft.	46 ft.	35 ft.	28 ft.	23 ft.
10 AWG	0.99	217 ft.	109 ft.	73 ft.	55 ft.	44 ft.	37 ft.

Standard Non-XT 24V Voltage Drop and Wire Length Distance Chart (3% Drop or 24V)

Wire Gauge	Copper Wire Resistance (Ω/kFT)	10W (0.42A)	20W (0.83A)	30W (1.25A)	40W (1.67A)	50W (2.08A)	60W (2.50A)	70W (2.92A)	80W (3.33A)	90W (3.75A)	96W (4A)
22 AWG	16.14	54 ft.	27 ft.	18 ft.	14 ft.	11 ft.	9 ft.	8 ft.	7 ft.	6 ft.	6 ft.
20 AWG	10.15	86 ft.	43 ft.	29 ft.	22 ft.	18 ft.	15 ft.	13 ft.	11 ft.	10 ft.	9 ft.
18 AWG	6.39	136 ft.	68 ft.	46 ft.	34 ft.	28 ft.	23 ft.	20 ft.	17 ft.	16 ft.	15 ft.
16 AWG	4.02	216 ft.	108 ft.	72 ft.	54 ft.	44 ft.	36 ft.	31 ft.	27 ft.	24 ft.	23 ft.
14 AWG	2.53	343 ft.	172 ft.	115 ft.	86 ft.	69 ft.	58 ft.	49 ft.	43 ft.	39 ft.	36 ft.
12 AWG	1.59	545 ft.	273 ft.	182 ft.	137 ft.	109 ft.	91 ft.	78 ft.	69 ft.	61 ft.	57 ft.
10 AWG	0.99	865 ft.	433 ft.	289 ft.	217 ft.	173 ft.	145 ft.	124 ft.	109 ft.	97 ft.	91 ft.

Note: These tables provide general guidelines for determining Wire Gauge based on total load and distance from LED driver to beginning of luminaire.

ALLOY LED® Specifications

ACCESSORIES (INCLUDED)

Mounting and Installation Accessories

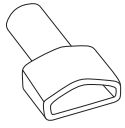

5 Splice Sleeves



10 Waterproof End Caps

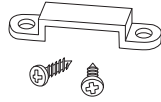

10 Mounting Clips
20 Screws



3M 9731 Silicone Rated Adhesive Tape

AL-01-01-9992 (50 ft.)
AL-01-01-9993 (100 ft.)

ACCESSORIES (SOLD SEPARATELY)

Wet Location Junction Boxes

Provide a waterproof seal for wire connections, and are useful for connections between LED fixtures and low voltage power.

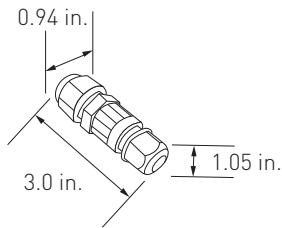

AL-98-05-99001

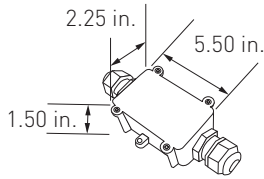

AL-98-05-99002-2

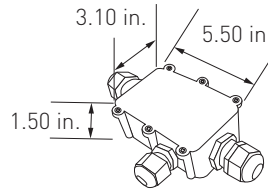

AL-98-05-99002-3

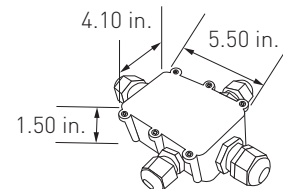

AL-98-05-99002-4

Item Number	Description	Maximum Voltage	Dimensions
AL-98-05-99001	Waterproof Cable Interconnector	450V AC	2.05 x 0.84 x 0.84 in.
AL-98-05-99002-2	Waterproof Junction Box - 2 Port	450V AC	5.5 x 2.25 x 1.46 in.
AL-98-05-99002-3	Waterproof Junction Box - 3 Port	450V AC	5.5 x 3.1 x 1.46 in.
AL-98-05-99002-4	Waterproof Junction Box - 4 Port	450V AC	5.5 x 4.1 x 1.46 in.

Reduced Hotspot Pairings (Hotspot Rating from 0-5)

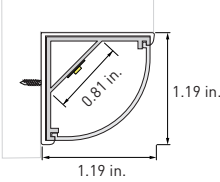
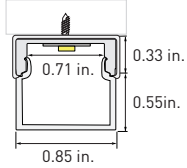
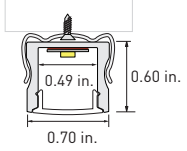
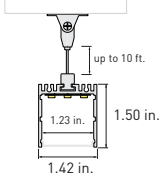
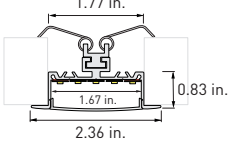
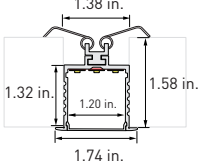
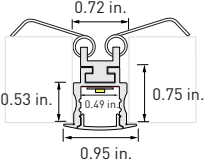
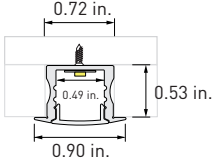
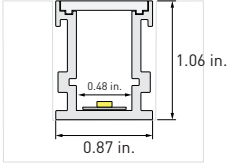
<p>Surfa 2X: Corner-Mount</p>  <p>Hotspot Rating: 0</p> <ul style="list-style-type: none"> <input checked="" type="checkbox"/> Solder <input checked="" type="checkbox"/> Connector <input type="checkbox"/> AmpChamp 	<p>Surfa 6 Surround: Surface-Mount</p>  <p>Hotspot Rating: 0</p> <ul style="list-style-type: none"> <input checked="" type="checkbox"/> Solder <input checked="" type="checkbox"/> Connector <input type="checkbox"/> AmpChamp 	<p>Surfa 7: Surface-Mount</p>  <p>Hotspot Rating: 0</p> <ul style="list-style-type: none"> <input checked="" type="checkbox"/> Solder <input checked="" type="checkbox"/> Connector <input type="checkbox"/> AmpChamp
<p>Suspan 1: Suspended</p>  <p>Hotspot Rating: 0</p> <ul style="list-style-type: none"> <input checked="" type="checkbox"/> Solder <input checked="" type="checkbox"/> Connector <input type="checkbox"/> AmpChamp 	<p>Ankr 1: In-Wall</p>  <p>Hotspot Rating: 0</p> <ul style="list-style-type: none"> <input checked="" type="checkbox"/> Solder <input checked="" type="checkbox"/> Connector <input type="checkbox"/> AmpChamp 	<p>Ankr 2: In-Wall</p>  <p>Hotspot Rating: 0</p> <ul style="list-style-type: none"> <input checked="" type="checkbox"/> Solder <input checked="" type="checkbox"/> Connector <input type="checkbox"/> AmpChamp
<p>Ankr 3: In-Wall</p>  <p>Hotspot Rating: 0</p> <ul style="list-style-type: none"> <input checked="" type="checkbox"/> Solder <input checked="" type="checkbox"/> Connector <input type="checkbox"/> AmpChamp 	<p>Ankr 4: Mud-In</p>  <p>Hotspot Rating: 0</p> <ul style="list-style-type: none"> <input checked="" type="checkbox"/> Solder <input checked="" type="checkbox"/> Connector <input type="checkbox"/> AmpChamp 	<p>Duro 1: In-Ground</p>  <p>Hotspot Rating: 0</p> <ul style="list-style-type: none"> <input checked="" type="checkbox"/> Solder <input checked="" type="checkbox"/> Connector <input type="checkbox"/> AmpChamp

ALLOY LED® Specifications

COMPATIBLE CHANNELS (Diagrams below not to scale)

Other Compatible Pairings (Hotspot Rating from 0-5)

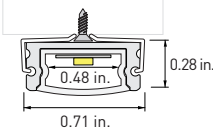
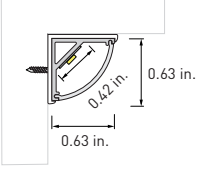
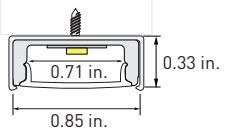
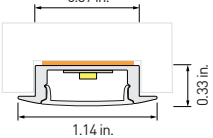
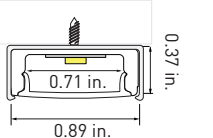
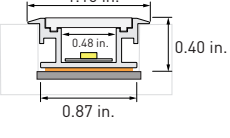
<p>Surfa 1: Surface-Mount</p>  <p>Hotspot Rating: 2</p> <ul style="list-style-type: none"> <input checked="" type="checkbox"/> Solder <input type="checkbox"/> Connector <input type="checkbox"/> AmpChamp 	<p>Surfa 2: Corner-Mount</p>  <p>Hotspot Rating: 2</p> <ul style="list-style-type: none"> <input checked="" type="checkbox"/> Solder <input checked="" type="checkbox"/> Connector <input type="checkbox"/> AmpChamp 	<p>Surfa 6: Surface-Mount</p>  <p>Hotspot Rating: 5</p> <ul style="list-style-type: none"> <input checked="" type="checkbox"/> Solder <input checked="" type="checkbox"/> Connector <input type="checkbox"/> AmpChamp
<p>Naro 4: Recessed</p>  <p>Hotspot Rating: 5</p> <ul style="list-style-type: none"> <input checked="" type="checkbox"/> Solder <input checked="" type="checkbox"/> Connector <input type="checkbox"/> AmpChamp 	<p>Polymer: Surface-Mount</p>  <p>Hotspot Rating: 4</p> <ul style="list-style-type: none"> <input checked="" type="checkbox"/> Solder <input checked="" type="checkbox"/> Connector <input type="checkbox"/> AmpChamp 	<p>Duro 2: In-Ground</p>  <p>Hotspot Rating: 2</p> <ul style="list-style-type: none"> <input checked="" type="checkbox"/> Solder <input checked="" type="checkbox"/> Connector <input type="checkbox"/> AmpChamp

ALLOY LED[®] Specifications

RECOMMENDED POWER SUPPLIES (SOLD SEPARATELY)



Alloy LED PowerFactor™ Dimmable Power Supplies with Integrated UL Listed Junction Box
Compact, highly efficient, and code-compliant power supply with versatile and smooth dimming capabilities.

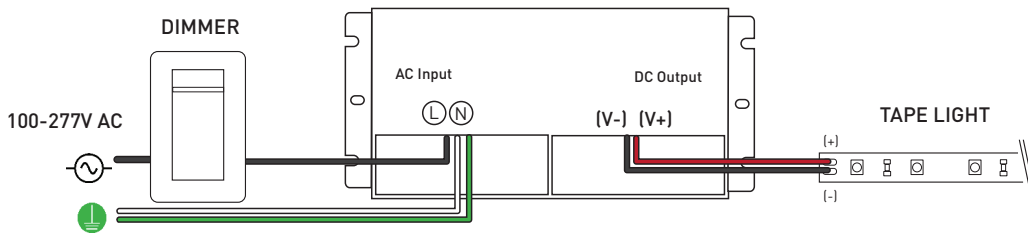

Wiring diagram is for reference only. Please refer to dimmer wiring specifications sheet for accurate directions.

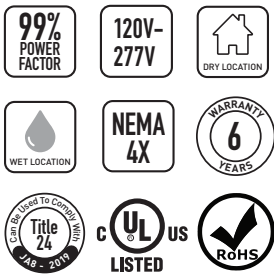

Single Tap Models

Item Number	Output Voltage	Wattage	Wet Location	Minimum Load	Dimensions (L x W x H)	Class 2
AL-98-10-12030	12V DC	30W	Yes (NEMA 4X)	10%	6.50 x 3.72 x 1.02 in.	Yes
AL-98-10-12060	12V DC	60W	Yes (NEMA 4X)	10%	7.40 x 3.72 x 1.02 in.	Yes
AL-98-10-12120	12V DC	120W	Yes (NEMA 4X)	10%	8.66 x 3.72 x 1.57 in.	No
AL-98-10-24030	24V DC	30W	Yes (NEMA 4X)	10%	6.50 x 3.72 x 1.02 in.	Yes
AL-98-10-24060	24V DC	60W	Yes (NEMA 4X)	10%	7.40 x 3.72 x 1.02 in.	Yes
AL-98-10-24096	24V DC	96W	Yes (NEMA 4X)	10%	8.66 x 3.72 x 1.57 in.	Yes
AL-98-10-24150	24V DC	150W	Yes (NEMA 4X)	10%	10.24 x 4.13 x 1.77 in.	No
AL-98-10-24200	24V DC	200W	Yes (NEMA 4X)	10%	10.24 x 4.13 x 1.77 in.	No
AL-98-10-24300	24V DC	300W	Yes (NEMA 4X)	10%	10.94 x 4.33 x 1.77 in.	No

Class 2 Compliant Multi-Tap Models

Item Number	Output Voltage	Wattage	Wet Location	Minimum Load	Dimensions (L x W x H)	Class 2
AL-98-10-12300-MT	12V DC	300W	Yes (NEMA 4X)	10%	11.85 x 4.33 x 1.77 in.	Yes
AL-98-10-24192-MT	24V DC	192W	Yes (NEMA 4X)	10%	10.94 x 4.33 x 1.77 in.	Yes
AL-98-10-24288-MT	24V DC	288W	Yes (NEMA 4X)	10%	11.85 x 4.33 x 1.77 in.	Yes

Note: PowerFactor assumes 80% load.
Inspectors prefer power supply to be used with junction box.
For dimmer compatibility, refer to drivers specification sheet.

ALLOY LED® Specifications

RECOMMENDED POWER SUPPLIES (SOLD SEPARATELY)

Alloy LED Primavolt® No Minimum Load Dimmable Power Supplies with ETL Listed Junction Box
Code-compliant power supply with versatile and smooth dimming capabilities. Compatible with Incandescent, On/Off, ELV and MLV dimmers.



Dry Location Model
White model for 60W and lower



Wet Location Model
Black model for 80W and higher

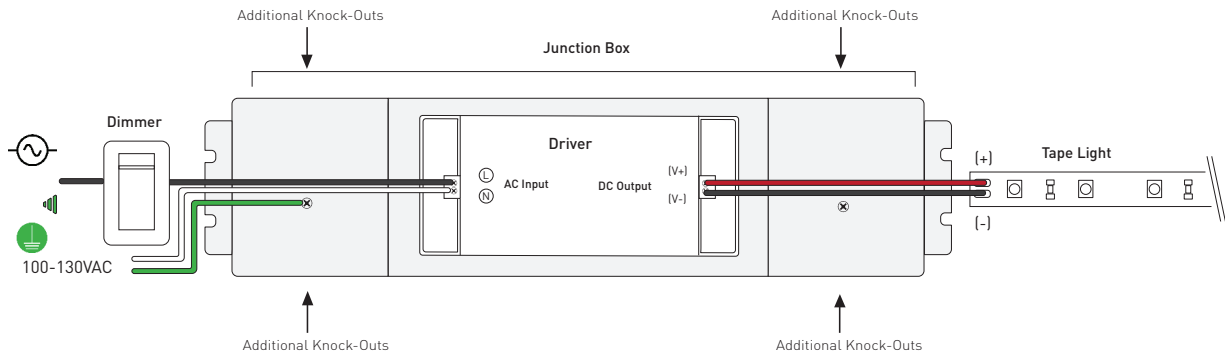

Wiring diagram is for reference only. Please refer to dimmer wiring specifications sheet for accurate directions.

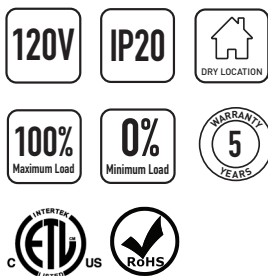

Item Number	Output Voltage	Wattage	Minimum Load	Dimensions (Junction Box) (L x W x H)	Class 2
AL-98-03-12024-NM	12V DC	24W	0%	13.78 x 3.03 x 1.46 in.	Yes
AL-98-03-12048-NM	12V DC	48W	0%	13.78 x 3.03 x 1.46 in.	Yes
AL-98-03-12060-NM	12V DC	60W	0%	13.78 x 3.03 x 1.46 in.	Yes
AL-98-03-12080-NM	12V DC	80W	0%	14.96 x 3.03 x 2.24 in.	No
AL-98-03-12120-NM	12V DC	120W	0%	14.96 x 3.03 x 2.24 in.	No
AL-98-03-24024-NM	24V DC	24W	0%	13.78 x 3.03 x 1.46 in.	Yes
AL-98-03-24048-NM	24V DC	48W	0%	13.78 x 3.03 x 1.46 in.	Yes
AL-98-03-24060-NM	24V DC	60W	0%	13.78 x 3.03 x 1.46 in.	Yes
AL-98-03-24080-NM	24V DC	80W	0%	14.96 x 3.03 x 2.24 in.	Yes
AL-98-03-24096-NM	24V DC	96W	0%	14.96 x 3.03 x 2.24 in.	Yes
AL-98-03-24150-NM	24V DC	150W	0%	15.98 x 3.43 x 2.36 in.	No
AL-98-03-24200-NM	24V DC	200W	0%	15.98 x 3.43 x 2.36 in.	No

Note: Alloy LED strongly recommends using Listed Class 2 power supplies for all installations. Always install in accordance with local and national electrical code regulations. Inspectors prefer power supply to be used with junction box. For dimmer compatibility, refer to drivers specification sheet.

ALLOY LED® Specifications

RECOMMENDED POWER SUPPLIES (SOLD SEPARATELY)

ELV Dimmable Power Supplies for Remote Enclosures

The drivers are derated, but when installed in a small enclosure with no heatsink or air circulation, we recommend a maximum load of 40W.

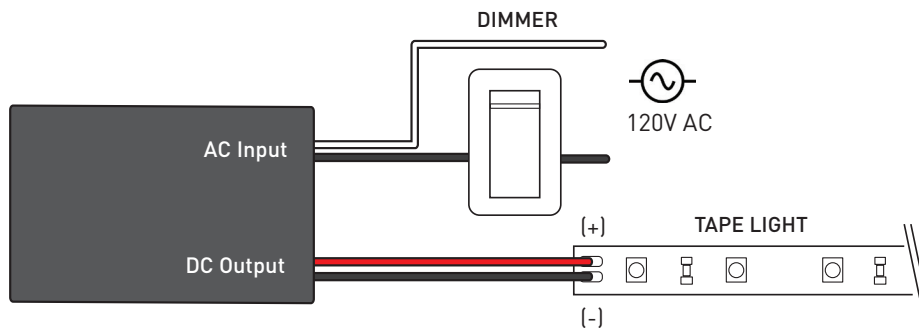

Wiring diagram is for reference only. Please refer to dimmer wiring specifications sheet for accurate directions.

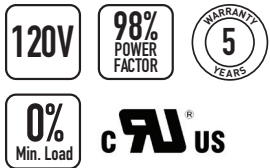

Item Number	Output	Wattage	Dimensions (L x W x H)	Class 2
AL-98-08-12060	12V DC	60W	2.66 x 1.30 x 0.83 in.	Yes
AL-98-08-24060	24V DC	60W	2.66 x 1.30 x 0.83 in.	Yes

Note: Inspectors prefer power supply to be used with junction box.
For dimmer compatibility, refer to drivers specification sheet.

ALLOY LED® Specifications

DIMMING ACCESSORIES (SOLD SEPARATELY)

Lutron® Dimming Accessories

By participating in Lutron's OEM Advantage program, Alloy LED is able to offer a range of the highest quality low voltage power supplies and selected controls on the market.



Hi-lume Premier
0.1% EcoSystem /
3-wire LED Driver
(96W 24VDC)



Hi-lume 1% LED Driver 40W
- EcoSystem / 3-wire control
- 2-wire 120V forward
phase control



Lutron Vive PowPak RF Module
- RF module for EcoSystem LED
driver control
- Use with the Lutron EcoSystem
drivers shown to "Vive-enable"
Alloy LED products

Lutron® Hi-lume LED Drivers

Item Number	Output	Wattage	Minimum Load	Class 2
AL-98-07-12040	12V DC	40W	N/A	Yes
AL-98-07-12040-3WIRE	12V DC	40W	N/A	Yes
AL-98-07-24040	24V DC	40W	N/A	Yes
AL-98-07-24040-3WIRE	24V DC	40W	N/A	Yes
AL-98-07-24096-3WIRE	24V DC	96W	N/A	Yes

Lutron® Controls

Item Number	Description	Voltage
AL-98-07-9901	EcoSystem Control Module	N/A
AL-98-07-9901-8	EcoSystem Control Module - 8-pack	N/A
AL-98-07-9950	CL Dimmer	120V AC
AL-98-07-9950-FPLATE	CL Dimmer faceplate	N/A

DIMMING ACCESSORIES (SOLD SEPARATELY)

Dimmers and Switches

SlimDim Wireless Dimmer Switch

Using long-range RF technology, these LED dimmers connect wirelessly to a receiver, offering freedom to mount anywhere. Can also be used as a fob for mobile, hand-held control.

AL-70-01-0001	SlimDim Wireless Dimmer
AL-70-01-0002	Single Color Receiver (96W max.) (sold separately)
AL-98-07-9950 -FPLATE	SlimDim Wall Plate (sold separately)

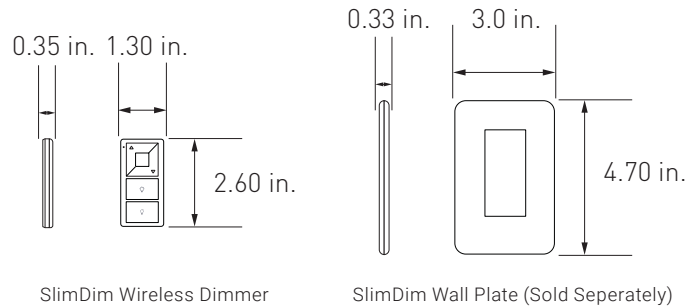

Remote Control Dimmer Switch

Provides full dimming and on/off control, and includes a touch wheel that allows for direct visual selection of brightness. It can also operate up to four independent zones.

AL-60-03-0001	Remote Control Dimmer Switch
AL-70-01-0002	Single Channel Receiver (sold separately)
AL-60-03-0004-V2	Wireless Receiver (RGB & RGBW) (sold separately)

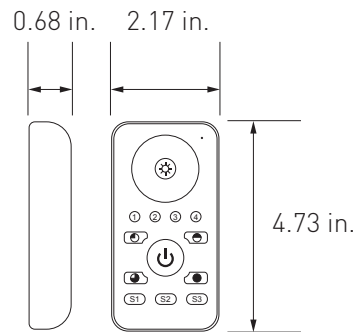

Single Channel Wireless Receiver

Pair with the Remote Control Dimmer Switch or the SlimDim Wireless Dimmer to dim PrimaLine tape lights. Use one remote to make independent lighting zones with multiple receivers with certain controllers.

AL-70-01-0002	Single Channel Wireless Receiver
---------------	----------------------------------

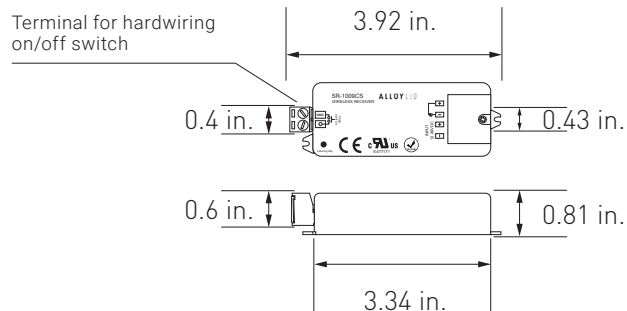

WIRING DIAGRAM

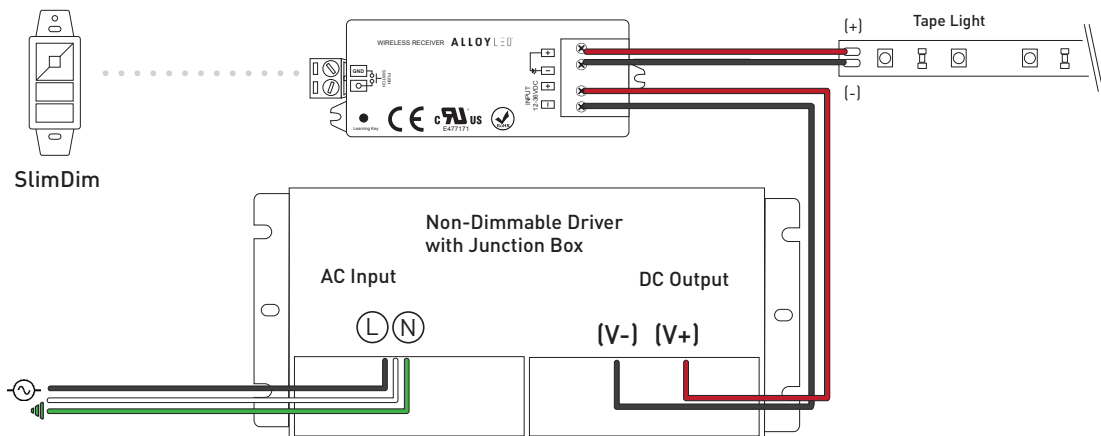

Note: specifications are representative of the diode type and not a particular tape light article.

2700K

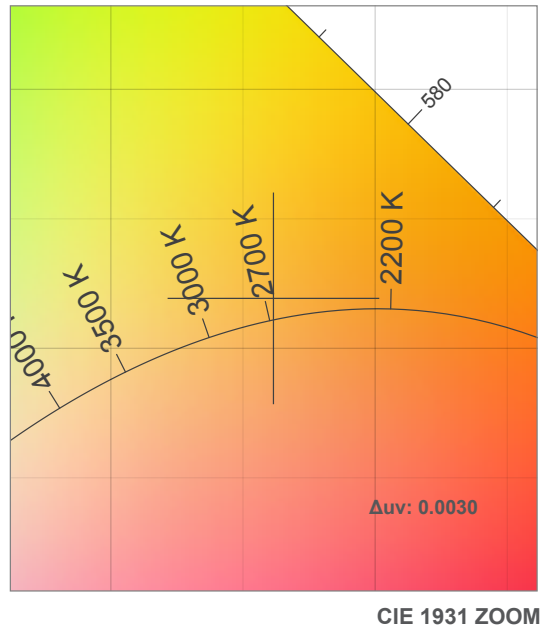
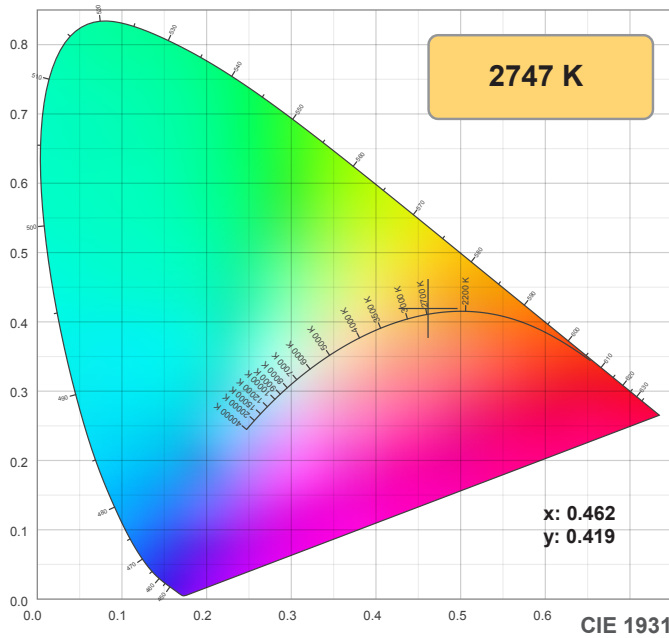

TM30: 95.0

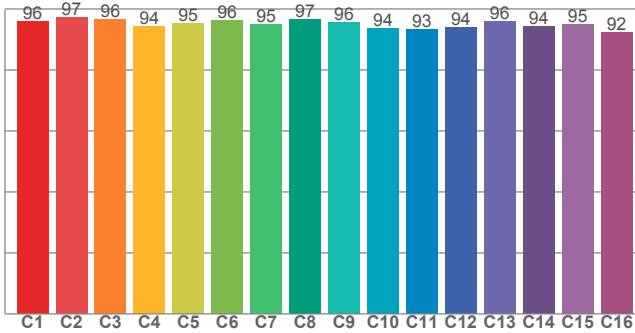

CRI: 97.2 (R1-R8)

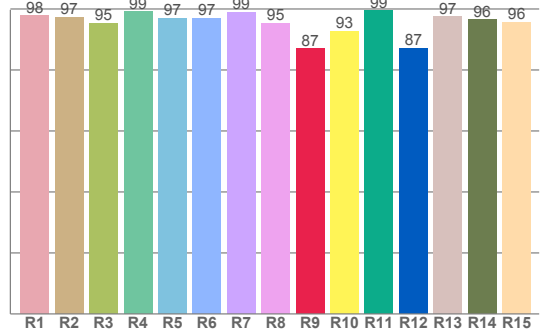

CQS: 93.4

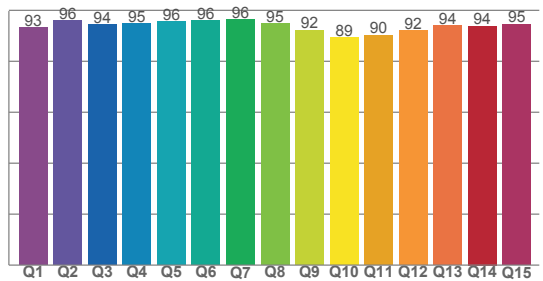

CRI R values, only R1-R8 are used to calculate final CRI value

R1	R2	R3	R4	R5	R6	R7	R8	R9	R10	R11	R12	R13	R14	R15
97.8	97.2	95.3	99.1	97.0	97.0	99.0	95.4	87.0	92.6	99.4	87.0	97.4	96.5	95.6

TM30 C values, 16 binned values out of total of 99 C values

C1	C2	C3	C4	C5	C6	C7	C8	C9	C10	C11	C12	C13	C14	C15	C16
95.9	97.1	96.5	94.3	95.3	96.3	94.8	96.6	95.7	93.6	93.4	94.0	95.8	94.3	94.9	92.2

CQS Q values

Q1	Q2	Q3	Q4	Q5	Q6	Q7	Q8	Q9	Q10	Q11	Q12	Q13	Q14	Q15
93.3	96.0	94.4	94.7	95.7	96.0	96.5	94.9	92.2	89.4	90.3	92.0	94.1	93.8	94.6

Color parameters

Color temperature	Color rendering index	Red component	Color fidelity	Color gamut	Color quality scale	Color coordinate cie 1931	Color coordinate cie 1931	Color coordinate	Color coordinate	Color deviation from black body
CCT	CRI	CRI R9	TM30 Rf	TM30 Rg	CQS	x	y	u	v	Δuv
2747 K	97.2	87.0	95.0	98.5	93.4	0.462	0.419	0.260	0.354	0.0030

Note: specifications are representative of the diode type and not a particular tape light article.

2700K

Rf 95.0
Fidelity index Rf

Rg 98.5
Gammut index Rg

Hue Bin	R _f	Graphic shifts (%)	
		Chroma	Hue
1	96	-2%	0%
2	97	-1%	0%
3	96	-2%	0%
4	94	-3%	-1%
5	95	-3%	1%
6	96	-1%	2%
7	95	-2%	2%
8	97	0%	2%
9	96	-1%	2%
10	94	0%	4%
11	93	1%	4%
12	94	2%	0%
13	96	0%	-3%
14	94	2%	-3%
15	95	-1%	0%
16	92	0%	-5%

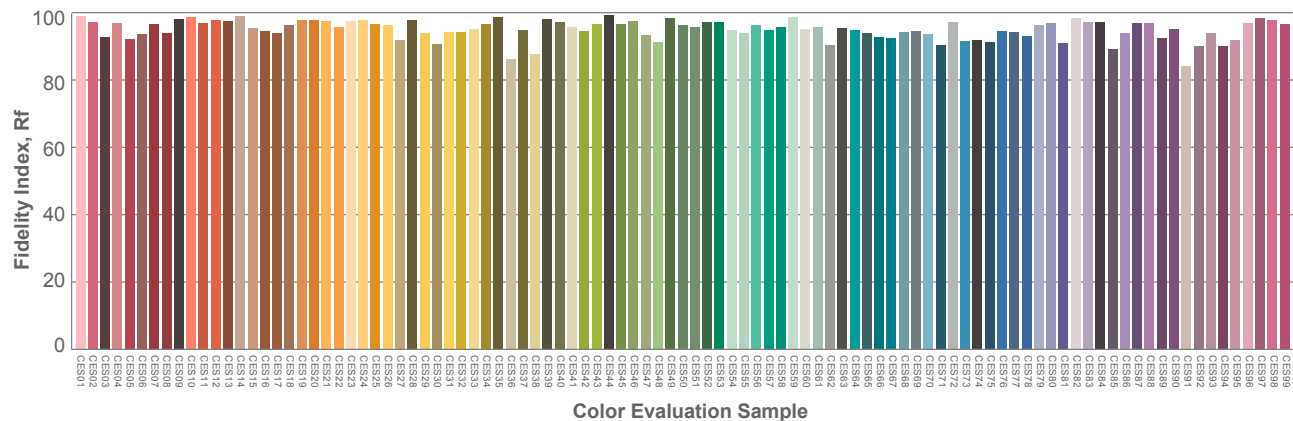
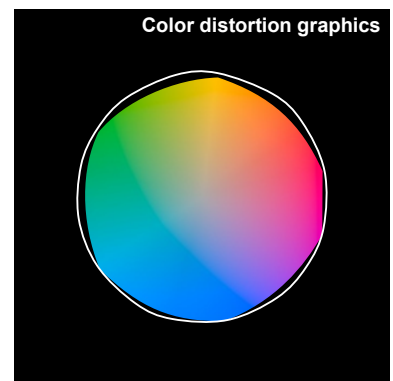
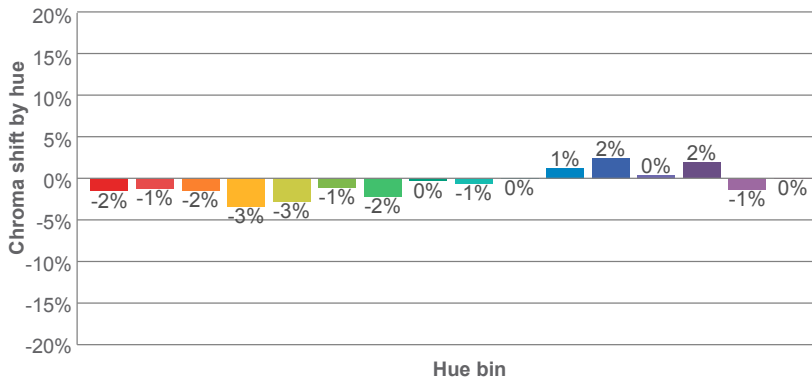
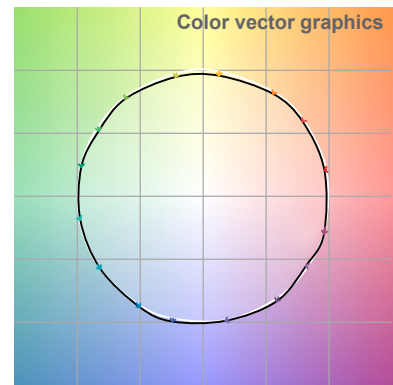
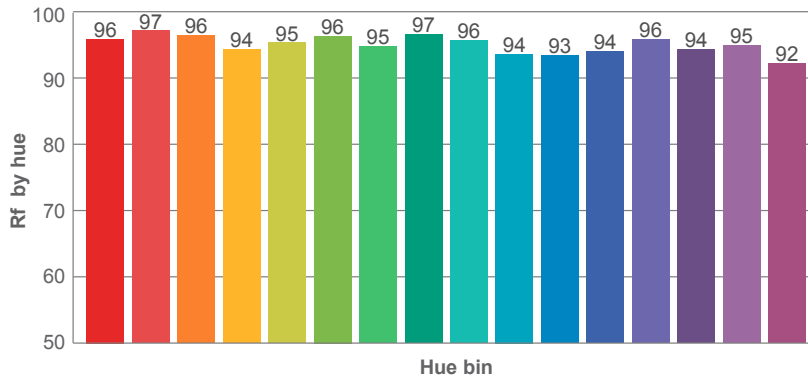
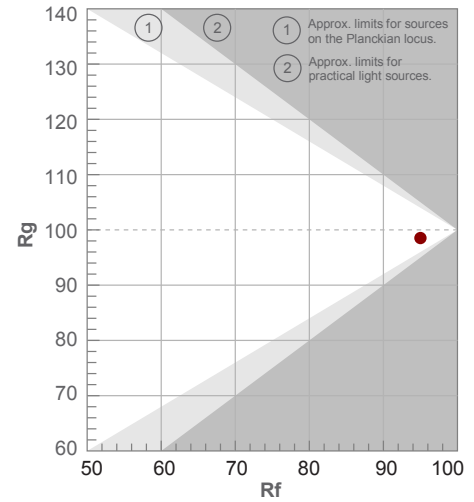

Note: specifications are representative of the diode type and not a particular tape light article.

2700K

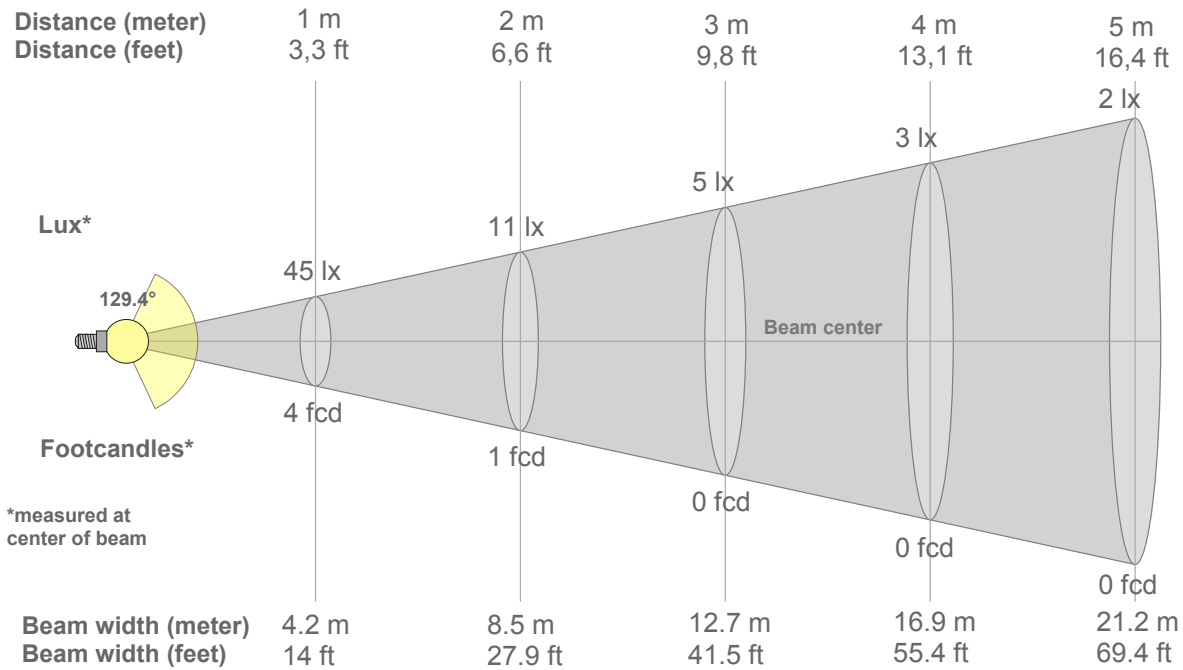

Beam intensities from 1-20m

1m	2m	3m	4m	5m	6m	7m	8m	9m	10m	11m	12m	13m	14m	15m	16m	17m	18m	19m	20m
3.3ft	6.6ft	9.8ft	13.1ft	16.4ft	19.7ft	23ft	26.2ft	29.5ft	32.8ft	36.1ft	39.4ft	42.7ft	45.9ft	49.2ft	52.5ft	55.8ft	59.1ft	62.3ft	65.6ft
45lx	11lx	5lx	3lx	2lx	1lx	1lx	1lx	1lx	0lx	0lx	0lx	0lx	0lx	0lx	0lx	0lx	0lx	0lx	0lx
4.1fcd	1fcd	0.5fcd	0.3fcd	0.2fcd	0.1fcd	0.1fcd	0.1fcd	0.1fcd	0fcd	0fcd	0fcd	0fcd	0fcd	0fcd	0fcd	0fcd	0fcd	0fcd	0fcd

Intensities in 0° c-plane

0°	9°	18°	27°	36°	45°	54°	63°	72°	81°	90°	99°	108°	117°	126°	135°	144°	153°	162°	171°
44.5	43.9	42.7	40.4	37.1	33.1	28.4	23.3	18.1	12.9	7.3	4.2	3.7	4.2	4.4	4.2	3.4	0.8	0.5	0.5
100%	99%	96%	91%	83%	74%	64%	52%	41%	29%	16%	9%	8%	9%	10%	9%	8%	2%	1%	1%

Intensities in 90° c-plane

0°	9°	18°	27°	36°	45°	54°	63°	72°	81°	90°	99°	108°	117°	126°	135°	144°	153°	162°	171°
44.5	43.9	42.7	40.4	37.1	33.1	28.4	23.3	18.1	12.9	7.3	4.2	3.7	4.2	4.4	4.2	3.4	0.8	0.5	0.5
100%	99%	96%	91%	83%	74%	64%	52%	41%	29%	16%	9%	8%	9%	10%	9%	8%	2%	1%	1%

Intensities in 180° c-plane

0°	9°	18°	27°	36°	45°	54°	63°	72°	81°	90°	99°	108°	117°	126°	135°	144°	153°	162°	171°
44.5	44.3	43.1	40.9	37.7	33.6	28.8	23.4	18.1	13.2	6.9	3.8	4.1	4.8	5.7	5.8	4.5	0.9	0.8	0.8
100%	99%	97%	92%	85%	76%	65%	52%	41%	30%	15%	9%	9%	11%	13%	13%	10%	2%	2%	2%

Intensities in 270° c-plane

0°	9°	18°	27°	36°	45°	54°	63°	72°	81°	90°	99°	108°	117°	126°	135°	144°	153°	162°	171°
44.5	44.3	43.1	40.9	37.7	33.6	28.8	23.4	18.1	13.2	6.9	3.8	4.1	4.8	5.7	5.8	4.5	0.9	0.8	0.8
100%	99%	97%	92%	85%	76%	65%	52%	41%	30%	15%	9%	9%	11%	13%	13%	10%	2%	2%	2%

Beam angle 50%	Field angle 10%	Cutoff angle 2,5%	Intensity ratio in 120° cone	Intensity ratio in 90° cone
129.4°	241.7°	303.1°	59.3%	38.8%

Note: specifications are representative of the diode type and not a particular tape light article.

3000K

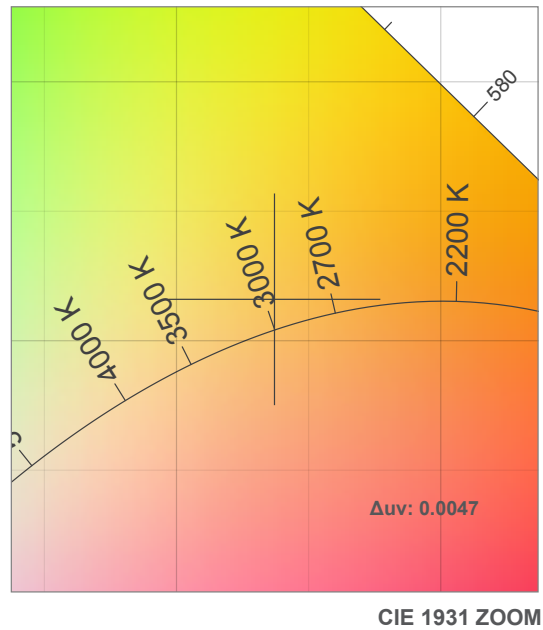
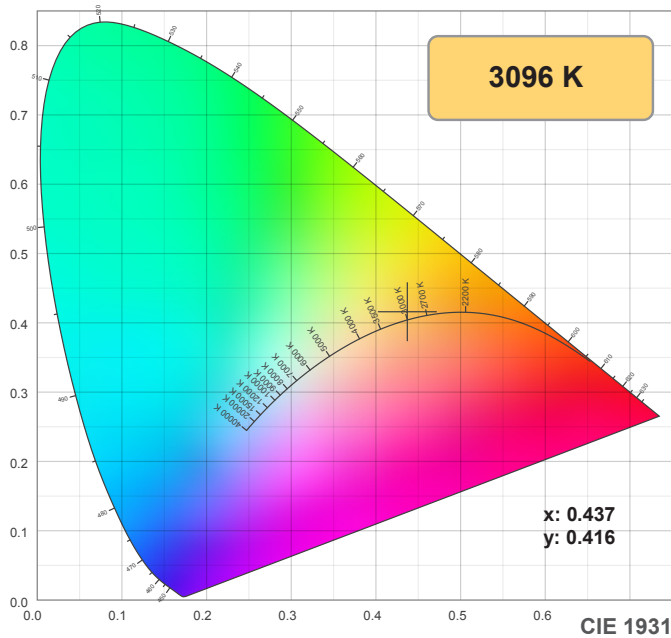

TM30: 91.0

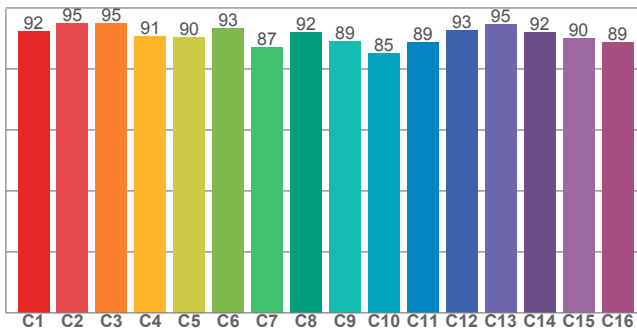

CRI: 95.1 (R1-R8)

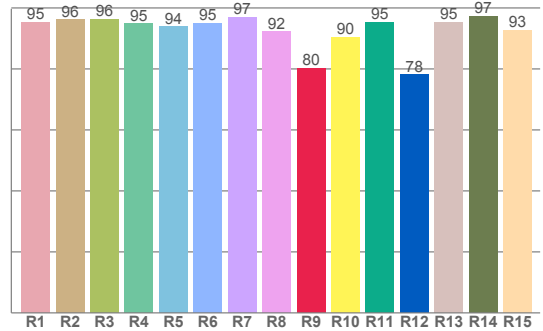

CQS: 92.1

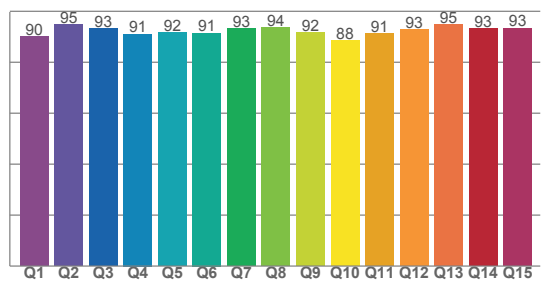

CRI R values, only R1-R8 are used to calculate final CRI value

R1	R2	R3	R4	R5	R6	R7	R8	R9	R10	R11	R12	R13	R14	R15
95.2	96.1	96.2	94.8	93.8	95.0	97.0	92.2	80.3	90.3	95.3	78.1	95.2	97.2	92.6

TM30 C values, 16 binned values out of total of 99 C values

C1	C2	C3	C4	C5	C6	C7	C8	C9	C10	C11	C12	C13	C14	C15	C16
92.3	95.0	94.9	90.7	90.4	93.3	87.1	91.9	89.1	85.1	88.7	92.5	94.6	91.8	90.0	88.7

CQS Q values

Q1	Q2	Q3	Q4	Q5	Q6	Q7	Q8	Q9	Q10	Q11	Q12	Q13	Q14	Q15
90.1	94.7	93.3	91.1	91.6	91.5	93.1	93.5	91.5	88.5	91.2	92.9	94.7	93.2	93.4

Color parameters

Color temperature	Color rendering index	Red component	Color fidelity	Color gamut	Color quality scale	Color coordinate cie 1931	Color coordinate cie 1931	Color coordinate	Color coordinate	Color deviation from black body
CCT	CRI	CRI R9	TM30 Rf	TM30 Rg	CQS	x	y	u	v	Δuv
3096 K	95.1	80.3	91.0	96.5	92.1	0.437	0.416	0.246	0.351	0.0047

Note: specifications are representative of the diode type and not a particular tape light article.

3000K

Rf 93.6
Fidelity index Rf

Rg 100.1
Gammut index Rg

Hue Bin	R _f	Graphic shifts (%)	
		Chroma	Hue
1	95	-1%	1%
2	97	0%	0%
3	96	0%	1%
4	94	-2%	-1%
5	93	-4%	0%
6	97	0%	1%
7	93	-3%	3%
8	97	-1%	1%
9	93	0%	5%
10	89	1%	6%
11	89	3%	7%
12	92	4%	1%
13	95	1%	-3%
14	93	4%	-4%
15	92	0%	-2%
16	90	2%	-7%

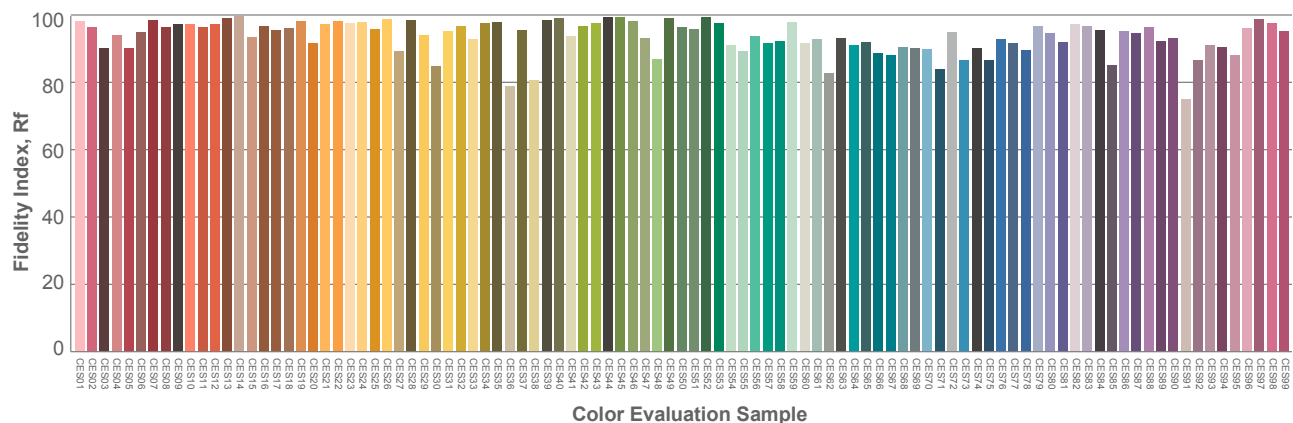
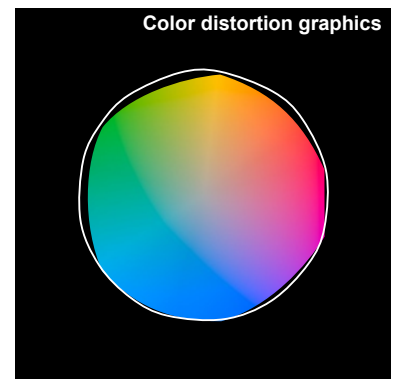
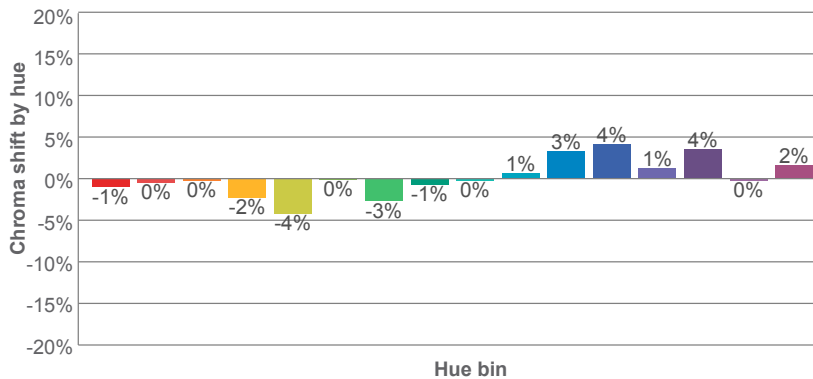
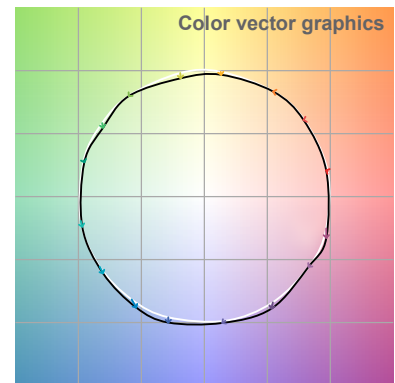
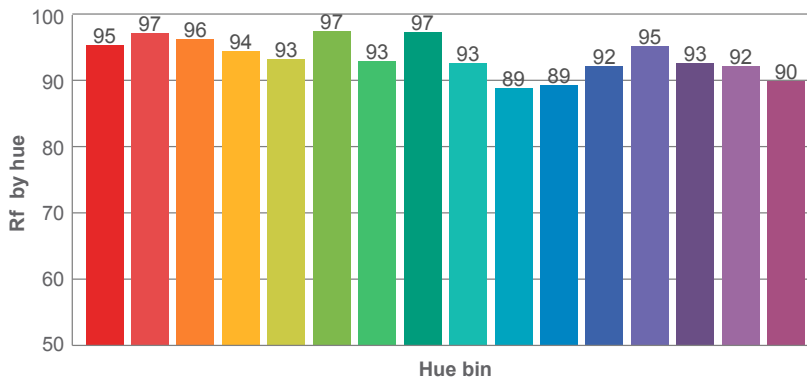
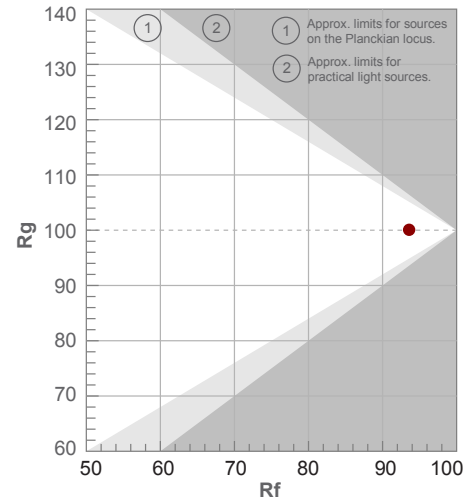

Note: specifications are representative of the diode type and not a particular tape light article.

3000K

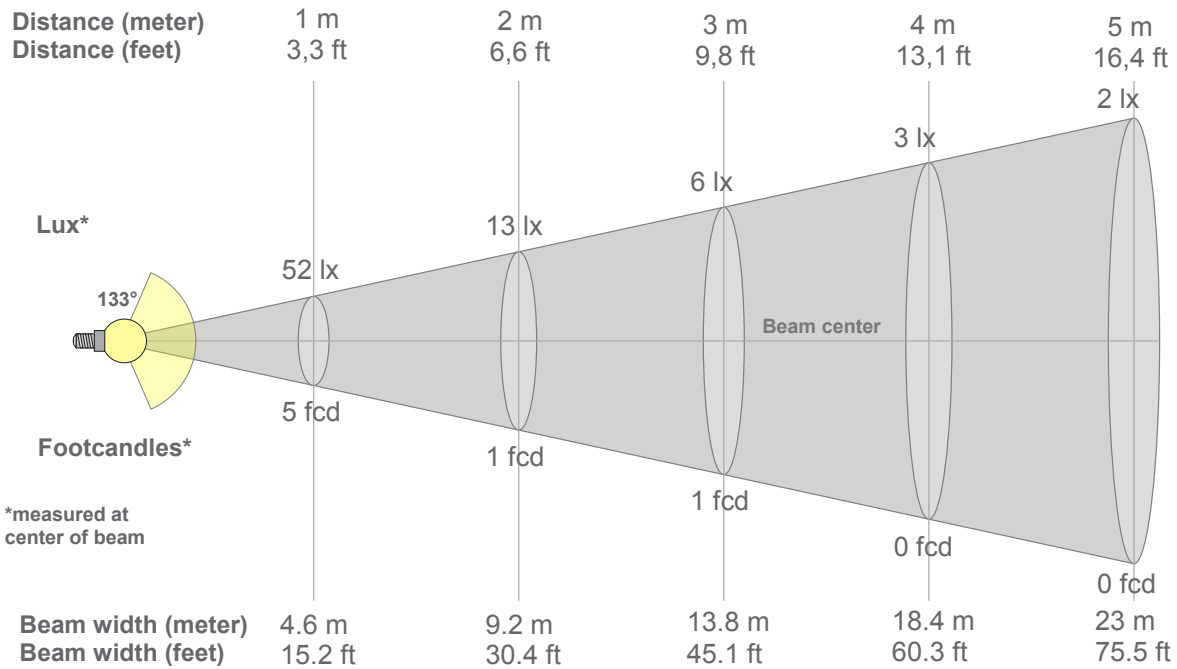

Beam intensities from 1-20m

1m	2m	3m	4m	5m	6m	7m	8m	9m	10m	11m	12m	13m	14m	15m	16m	17m	18m	19m	20m
3.3ft	6.6ft	9.8ft	13.1ft	16.4ft	19.7ft	23ft	26.2ft	29.5ft	32.8ft	36.1ft	39.4ft	42.7ft	45.9ft	49.2ft	52.5ft	55.8ft	59.1ft	62.3ft	65.6ft
52lx	13lx	6lx	3lx	2lx	1lx	1lx	1lx	1lx	1lx	0lx	0lx	0lx	0lx	0lx	0lx	0lx	0lx	0lx	0lx
4.8fcd	1.2fcd	0.5fcd	0.3fcd	0.2fcd	0.1fcd	0.1fcd	0.1fcd	0.1fcd	0fcd	0fcd	0fcd	0fcd	0fcd	0fcd	0fcd	0fcd	0fcd	0fcd	0fcd

Intensities in 0° c-plane

0°	9°	18°	27°	36°	45°	54°	63°	72°	81°	90°	99°	108°	117°	126°	135°	144°	153°	162°	171°
52.1	51.5	50.2	47.8	44.1	39.4	33.9	28.0	23.4	18.3	10.5	5.2	4.1	4.5	4.8	4.6	4.6	2.5	0.5	0.5
100%	99%	96%	92%	85%	76%	65%	54%	45%	35%	20%	10%	8%	9%	9%	9%	9%	5%	1%	1%

Intensities in 90° c-plane

0°	9°	18°	27°	36°	45°	54°	63°	72°	81°	90°	99°	108°	117°	126°	135°	144°	153°	162°	171°
52.1	51.5	50.2	47.8	44.1	39.4	33.9	28.0	23.4	18.3	10.5	5.2	4.1	4.5	4.8	4.6	4.6	2.5	0.5	0.5
100%	99%	96%	92%	85%	76%	65%	54%	45%	35%	20%	10%	8%	9%	9%	9%	9%	5%	1%	1%

Intensities in 180° c-plane

0°	9°	18°	27°	36°	45°	54°	63°	72°	81°	90°	99°	108°	117°	126°	135°	144°	153°	162°	171°
52.1	51.6	49.9	46.8	42.6	37.4	34.3	28.5	22.9	17.8	9.1	4.7	4.5	5.1	5.1	4.3	2.2	0.6	0.6	0.7
100%	99%	96%	90%	82%	72%	66%	55%	44%	34%	18%	9%	9%	10%	10%	8%	4%	1%	1%	1%

Intensities in 270° c-plane

0°	9°	18°	27°	36°	45°	54°	63°	72°	81°	90°	99°	108°	117°	126°	135°	144°	153°	162°	171°
52.1	51.6	49.9	46.8	42.6	37.4	34.3	28.5	22.9	17.8	9.1	4.7	4.5	5.1	5.1	4.3	2.2	0.6	0.6	0.7
100%	99%	96%	90%	82%	72%	66%	55%	44%	34%	18%	9%	9%	10%	10%	8%	4%	1%	1%	1%

Beam angle 50%	Field angle 10%	Cutoff angle 2,5%	Intensity ratio in 120° cone	Intensity ratio in 90° cone
133°	221.6°	301.8°	58.2%	37.8%

Note: specifications are representative of the diode type and not a particular tape light article.

4200K

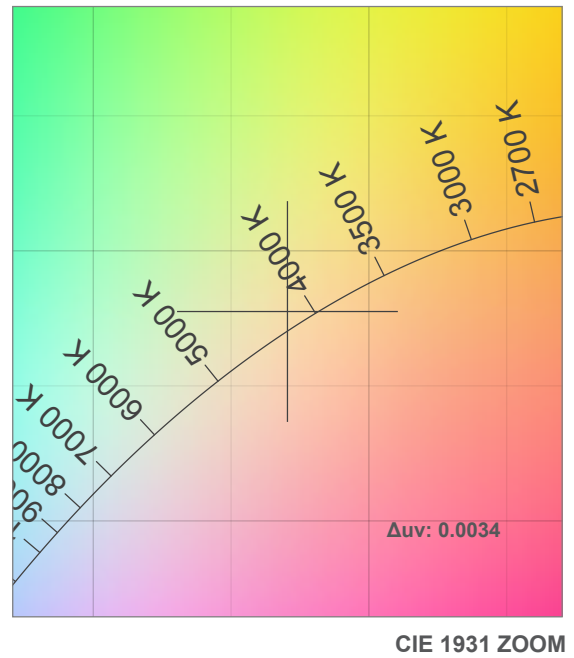
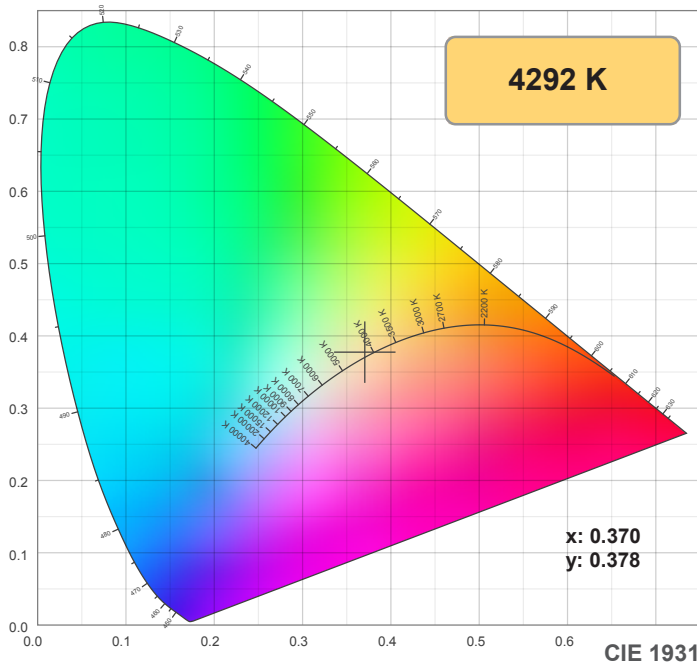

TM30: 90.4

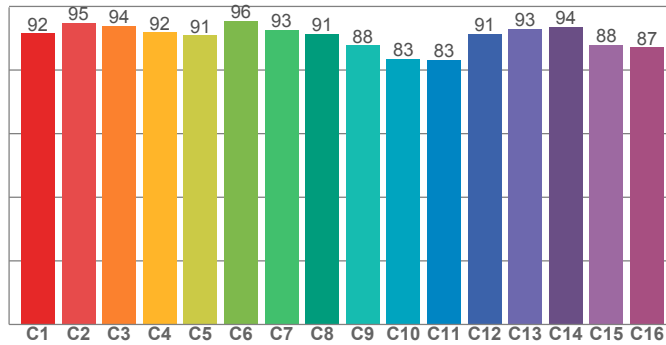

CRI: 94.2 (R1-R8)

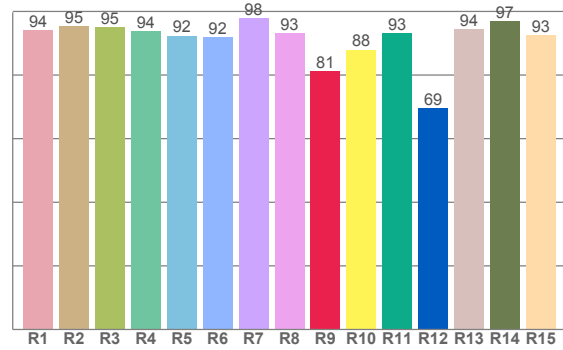

CRI R values, only R1-R8 are used to calculate final CRI value

R1	R2	R3	R4	R5	R6	R7	R8	R9	R10	R11	R12	R13	R14	R15
94.1	95.3	95.1	93.7	92.4	92.0	98.0	93.1	81.1	88.0	93.2	69.5	94.3	97.0	92.6

TM30 C values, 16 binned values out of total of 99 C values

C1	C2	C3	C4	C5	C6	C7	C8	C9	C10	C11	C12	C13	C14	C15	C16
91.6	94.8	93.9	91.9	90.9	95.5	92.6	91.4	87.8	83.5	83.3	91.4	93.0	93.6	87.9	87.2

CQS Q values

Q1	Q2	Q3	Q4	Q5	Q6	Q7	Q8	Q9	Q10	Q11	Q12	Q13	Q14	Q15
93.1	98.7	88.6	86.8	90.4	91.9	94.7	96.8	98.2	96.5	96.0	96.5	96.9	95.0	95.1

CQS: 93.4

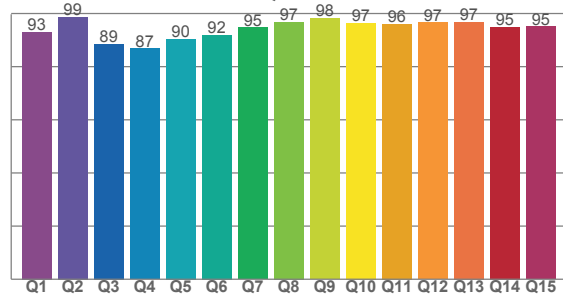

Color parameters

Color temperature	Color rendering index	Red component	Color fidelity	Color gamut	Color quality scale	Color coordinate cie 1931	Color coordinate cie 1931	Color coordinate	Color coordinate	Color deviation from black body
CCT	CRI	CRI R9	TM30 Rf	TM30 Rg	CQS	x	y	u	v	Δuv
4292 K	94.2	81.1	90.4	98.1	93.4	0.370	0.378	0.218	0.334	0.0034

Note: specifications are representative of the diode type and not a particular tape light article.

4200K

Rf 90.4
Fidelity index Rf

Rg 98.1
Gammut index Rg

Hue Bin	R _f	Graphic shifts (%)	
		Chroma	Hue
1	92	-3%	0%
2	95	-2%	0%
3	94	-2%	1%
4	92	-3%	0%
5	91	-5%	0%
6	96	-2%	0%
7	93	-4%	1%
8	91	-4%	3%
9	88	-3%	8%
10	83	-1%	9%
11	83	3%	9%
12	91	3%	3%
13	93	4%	-2%
14	94	1%	-2%
15	88	2%	-6%
16	87	1%	-7%

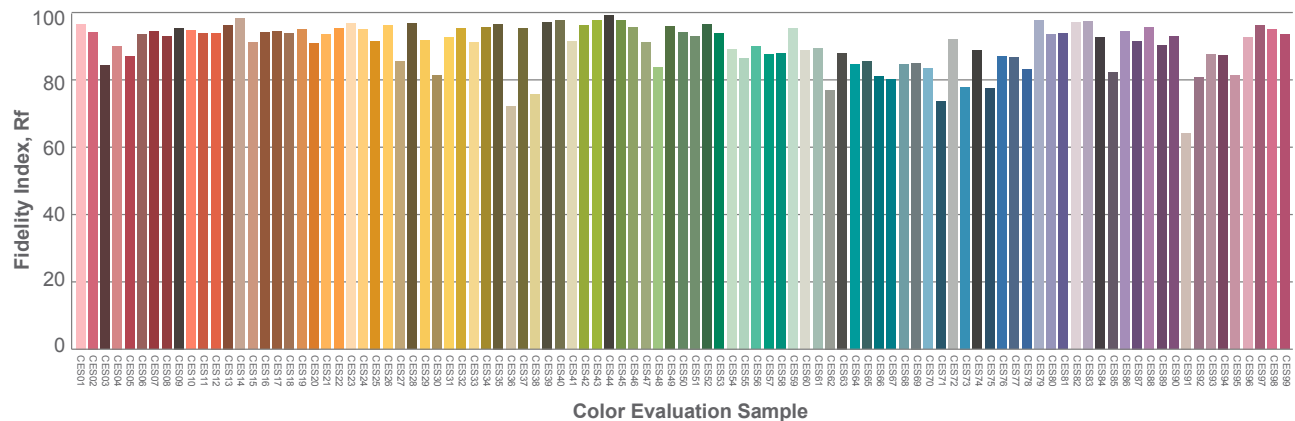
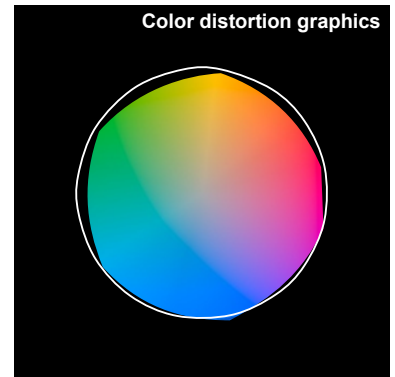
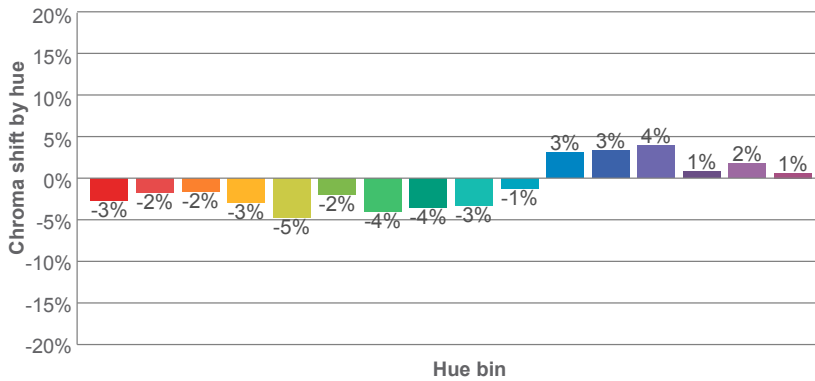
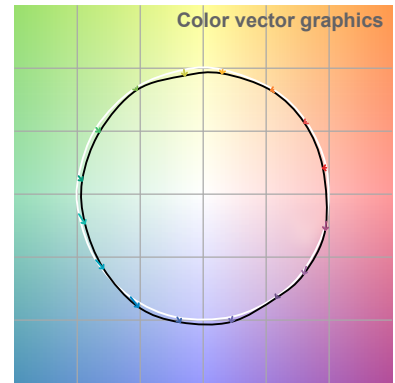
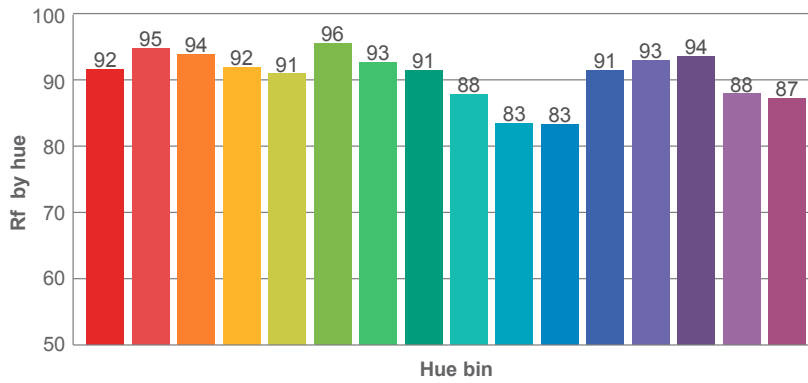
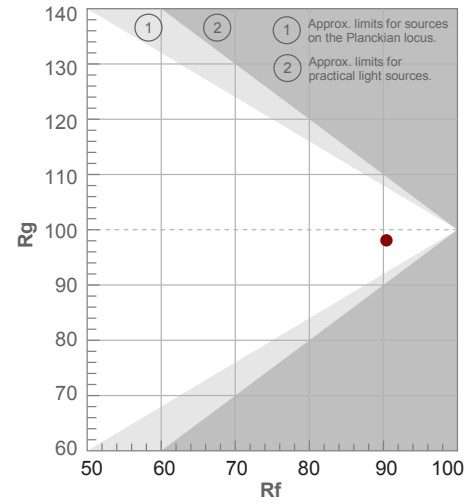

Note: specifications are representative of the diode type and not a particular tape light article.

4200K

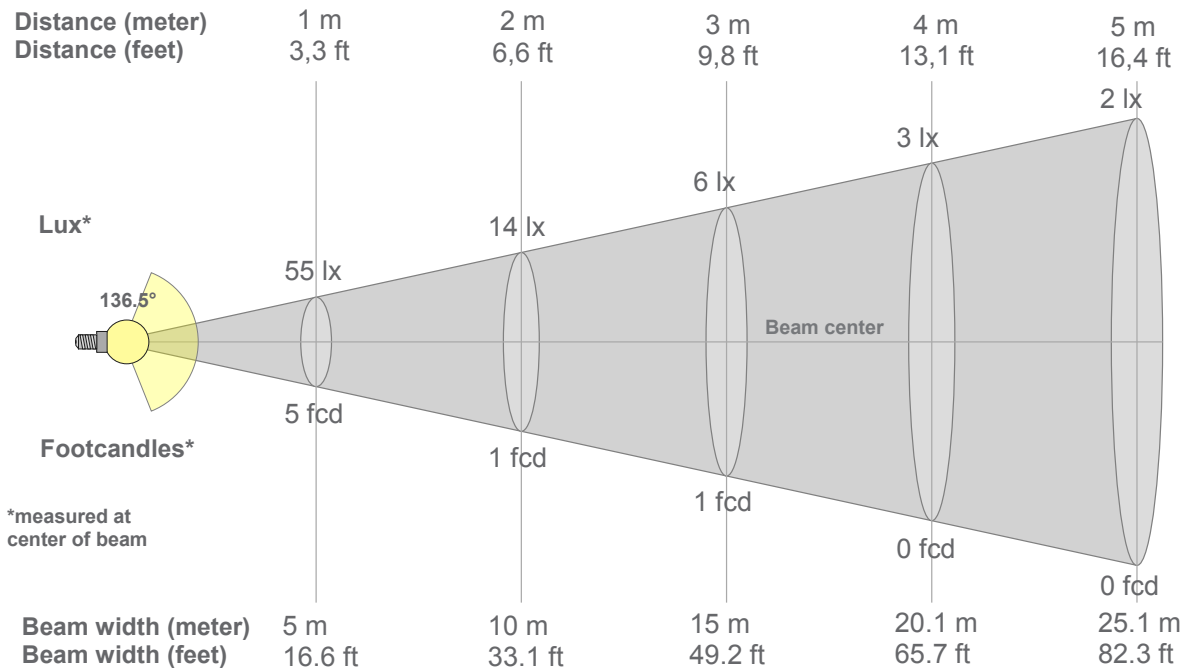

Beam intensities from 1-20m

1m	2m	3m	4m	5m	6m	7m	8m	9m	10m	11m	12m	13m	14m	15m	16m	17m	18m	19m	20m
3.3ft	6.6ft	9.8ft	13.1ft	16.4ft	19.7ft	23ft	26.2ft	29.5ft	32.8ft	36.1ft	39.4ft	42.7ft	45.9ft	49.2ft	52.5ft	55.8ft	59.1ft	62.3ft	65.6ft
55lx	14lx	6lx	3lx	2lx	2lx	1lx	1lx	1lx	1lx	0lx	0lx	0lx	0lx	0lx	0lx	0lx	0lx	0lx	0lx
5.1fcd	1.3fcd	0.6fcd	0.3fcd	0.2fcd	0.1fcd	0.1fcd	0.1fcd	0.1fcd	0.1fcd	0fcd	0fcd	0fcd	0fcd	0fcd	0fcd	0fcd	0fcd	0fcd	0fcd

Intensities in 0° c-plane

0°	9°	18°	27°	36°	45°	54°	63°	72°	81°	90°	99°	108°	117°	126°	135°	144°	153°	162°	171°
55.1	54.8	53.7	51.6	48.4	43.9	38.2	31.7	24.6	17.8	10.4	5.2	5.3	6.6	8.0	8.6	7.6	2.3	0.6	0.6
100%	99%	97%	94%	88%	80%	69%	57%	45%	32%	19%	10%	10%	12%	14%	16%	14%	4%	1%	1%

Intensities in 90° c-plane

0°	9°	18°	27°	36°	45°	54°	63°	72°	81°	90°	99°	108°	117°	126°	135°	144°	153°	162°	171°
55.1	54.8	53.7	51.6	48.4	43.9	38.2	31.7	24.6	17.8	10.4	5.2	5.3	6.6	8.0	8.6	7.6	2.3	0.6	0.6
100%	99%	97%	94%	88%	80%	69%	57%	45%	32%	19%	10%	10%	12%	14%	16%	14%	4%	1%	1%

Intensities in 180° c-plane

0°	9°	18°	27°	36°	45°	54°	63°	72°	81°	90°	99°	108°	117°	126°	135°	144°	153°	162°	171°
55.1	54.8	53.6	51.3	47.6	43.0	37.8	31.6	24.6	18.0	10.4	5.3	5.2	6.0	6.8	6.9	2.7	0.6	0.6	0.7
100%	99%	97%	93%	86%	78%	69%	57%	45%	33%	19%	10%	9%	11%	12%	12%	5%	1%	1%	1%

Intensities in 270° c-plane

0°	9°	18°	27°	36°	45°	54°	63°	72°	81°	90°	99°	108°	117°	126°	135°	144°	153°	162°	171°
55.1	54.8	53.6	51.3	47.6	43.0	37.8	31.6	24.6	18.0	10.4	5.3	5.2	6.0	6.8	6.9	2.7	0.6	0.6	0.7
100%	99%	97%	93%	86%	78%	69%	57%	45%	33%	19%	10%	9%	11%	12%	12%	5%	1%	1%	1%

Beam angle 50%	Field angle 10%	Cutoff angle 2,5%	Intensity ratio in 120° cone	Intensity ratio in 90° cone
136.5°	286.9°	302.8°	57.5%	37.1%

Note: specifications are representative of the diode type and not a particular tape light article.

5000K

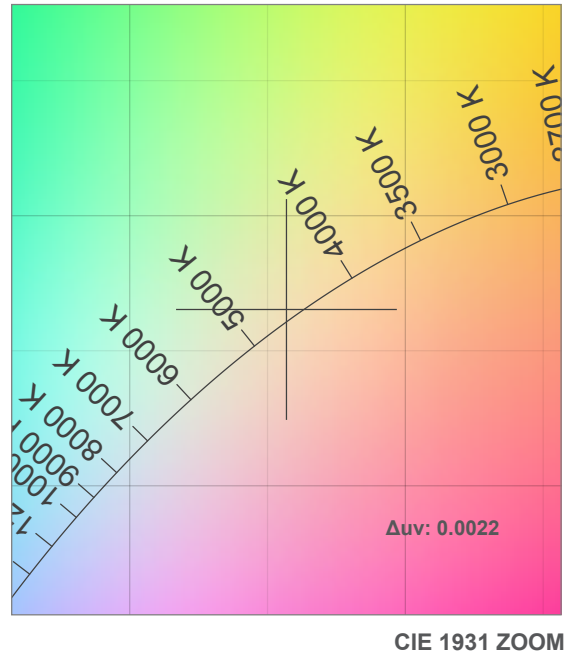
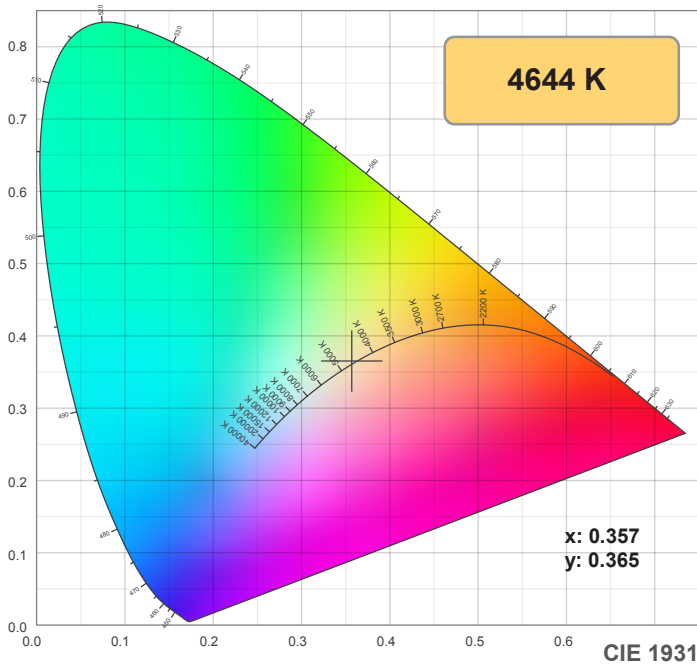

TM30: 89.4

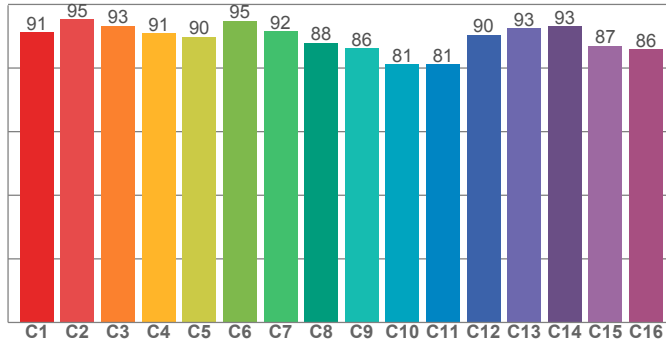

CRI: 94.1 (R1-R8)

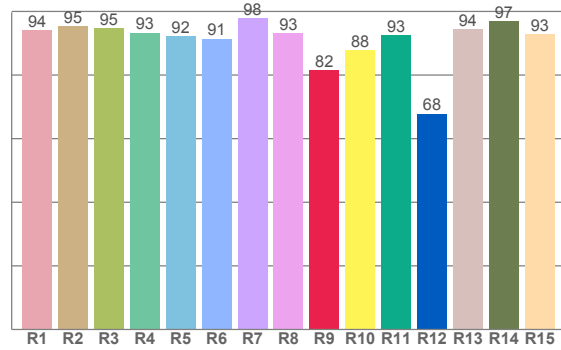

CQS: 92.6

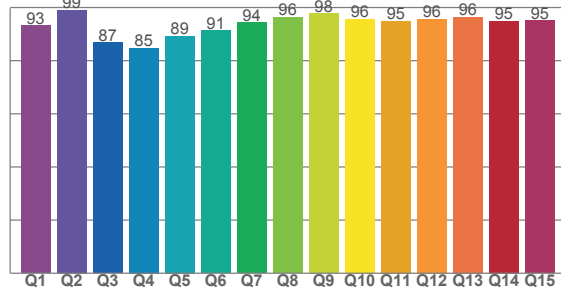

CRI R values, only R1-R8 are used to calculate final CRI value

R1	R2	R3	R4	R5	R6	R7	R8	R9	R10	R11	R12	R13	R14	R15
94.0	95.4	94.8	93.4	92.3	91.4	97.8	93.3	81.6	87.9	92.6	67.9	94.4	97.0	92.9

TM30 C values, 16 binned values out of total of 99 C values

C1	C2	C3	C4	C5	C6	C7	C8	C9	C10	C11	C12	C13	C14	C15	C16
91.2	95.3	93.2	91.0	89.9	94.9	91.5	87.9	86.1	81.2	81.2	90.5	92.5	93.1	87.0	85.9

CQS Q values

Q1	Q2	Q3	Q4	Q5	Q6	Q7	Q8	Q9	Q10	Q11	Q12	Q13	Q14	Q15
93.3	99.0	86.9	84.8	89.2	91.3	94.3	96.3	97.8	95.7	94.9	95.8	96.4	94.9	95.1

Color parameters

Color temperature	Color rendering index	Red component	Color fidelity	Color gamut	Color quality scale	Color coordinate cie 1931	Color coordinate cie 1931	Color coordinate	Color coordinate	Color deviation from black body
CCT	CRI	CRI R9	TM30 Rf	TM30 Rg	CQS	x	y	u	v	Δuv
4644 K	94.1	81.6	89.4	97.9	92.6	0.357	0.365	0.214	0.329	0.0022

Note: specifications are representative of the diode type and not a particular tape light article.

5000K

Rf 89.4
Fidelity index Rf

Rg 97.9
Gammut index Rg

Hue Bin	R _f	Graphic shifts (%)	
		Chroma	Hue
1	91	-3%	0%
2	95	-2%	1%
3	93	-2%	1%
4	91	-3%	0%
5	90	-5%	0%
6	95	-2%	0%
7	92	-5%	1%
8	88	-5%	5%
9	86	-4%	9%
10	81	-1%	11%
11	81	4%	11%
12	90	4%	4%
13	93	4%	-1%
14	93	1%	-2%
15	87	2%	-6%
16	86	1%	-7%

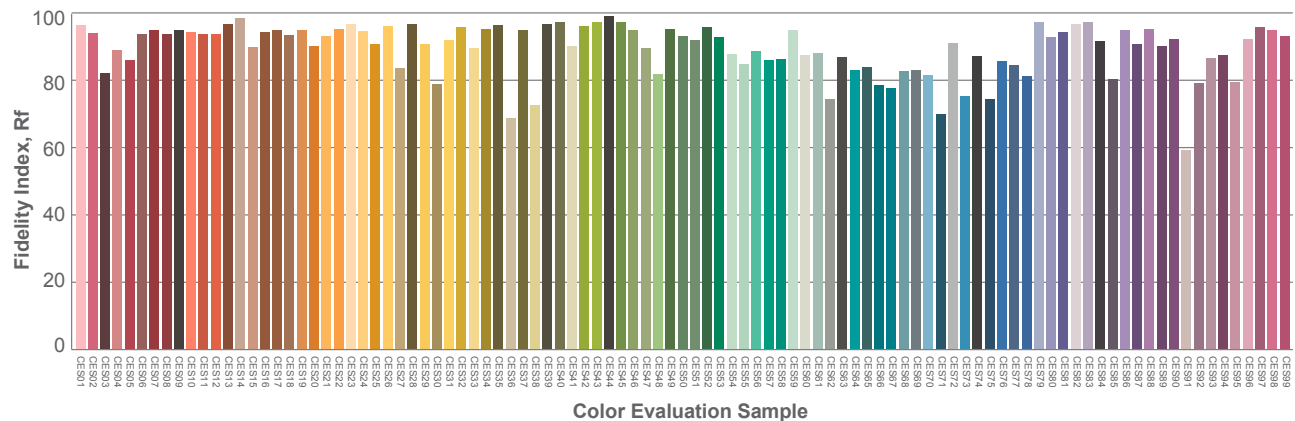
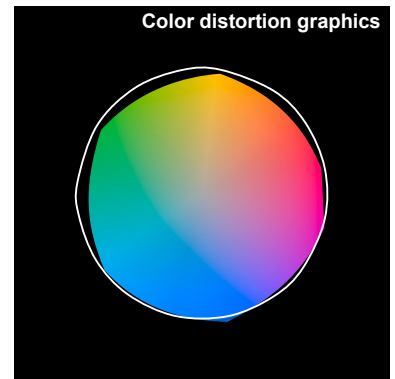
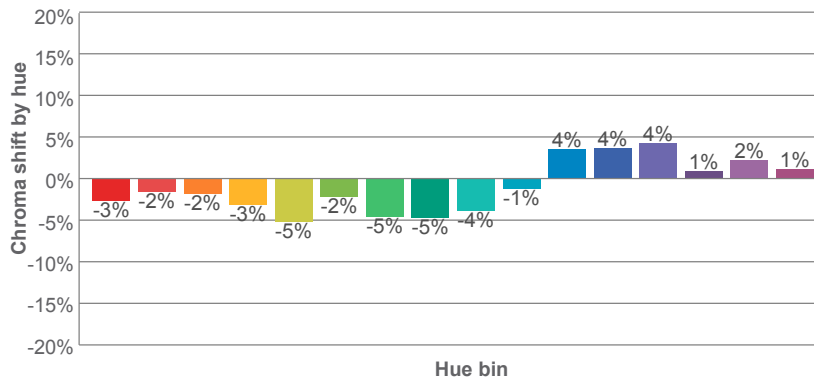
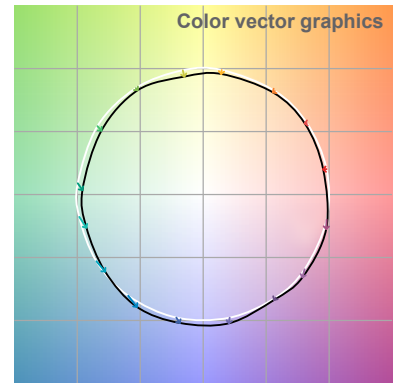
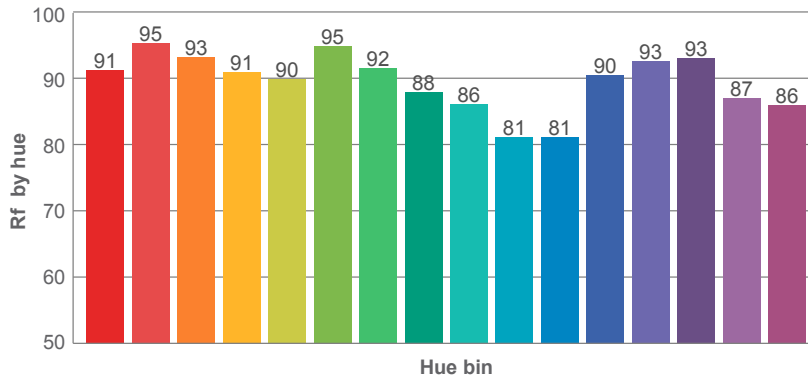
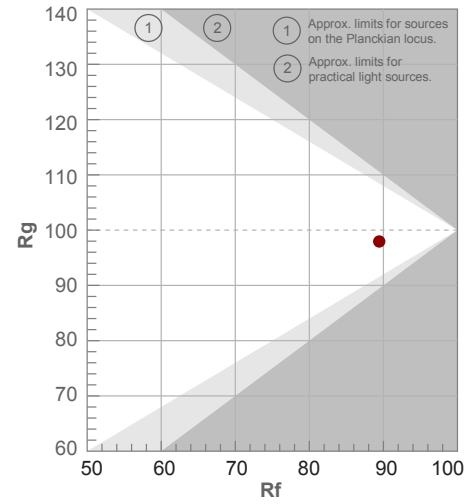

Note: specifications are representative of the diode type and not a particular tape light article.

5000K

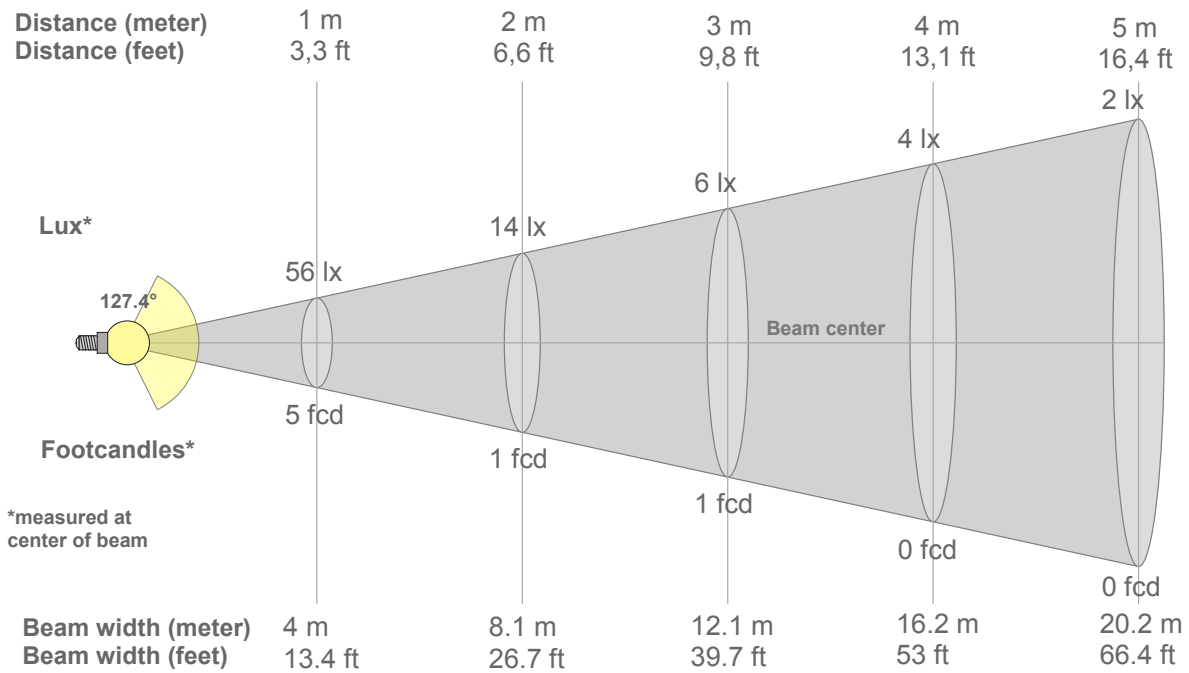

Beam intensities from 1-20m

1m	2m	3m	4m	5m	6m	7m	8m	9m	10m	11m	12m	13m	14m	15m	16m	17m	18m	19m	20m
3.3ft	6.6ft	9.8ft	13.1ft	16.4ft	19.7ft	23ft	26.2ft	29.5ft	32.8ft	36.1ft	39.4ft	42.7ft	45.9ft	49.2ft	52.5ft	55.8ft	59.1ft	62.3ft	65.6ft
56lx	14lx	6lx	4lx	2lx	2lx	1lx	1lx	1lx	1lx	0lx	0lx	0lx	0lx	0lx	0lx	0lx	0lx	0lx	0lx
5.2fcd	1.3fcd	0.6fcd	0.3fcd	0.2fcd	0.1fcd	0.1fcd	0.1fcd	0.1fcd	0.1fcd	0fcd	0fcd	0fcd	0fcd	0fcd	0fcd	0fcd	0fcd	0fcd	0fcd

Intensities in 0° c-plane

0°	9°	18°	27°	36°	45°	54°	63°	72°	81°	90°	99°	108°	117°	126°	135°	144°	153°	162°	171°
56.2	55.6	54.0	51.2	47.1	41.7	35.5	28.7	21.6	14.9	8.7	4.7	4.7	5.4	5.7	5.9	6.0	1.2	0.6	0.6
100%	99%	96%	91%	84%	74%	63%	51%	38%	26%	15%	8%	8%	10%	10%	11%	11%	2%	1%	1%

Intensities in 90° c-plane

0°	9°	18°	27°	36°	45°	54°	63°	72°	81°	90°	99°	108°	117°	126°	135°	144°	153°	162°	171°
56.2	55.6	54.0	51.2	47.1	41.7	35.5	28.7	21.6	14.9	8.7	4.7	4.7	5.4	5.7	5.9	6.0	1.2	0.6	0.6
100%	99%	96%	91%	84%	74%	63%	51%	38%	26%	15%	8%	8%	10%	10%	11%	11%	2%	1%	1%

Intensities in 180° c-plane

0°	9°	18°	27°	36°	45°	54°	63°	72°	81°	90°	99°	108°	117°	126°	135°	144°	153°	162°	171°
56.2	55.6	54.0	51.2	47.0	41.8	35.5	28.7	21.6	14.5	8.2	4.6	4.5	5.3	5.4	5.4	3.2	0.6	0.6	0.6
100%	99%	96%	91%	84%	74%	63%	51%	38%	26%	15%	8%	8%	10%	10%	10%	6%	1%	1%	1%

Intensities in 270° c-plane

0°	9°	18°	27°	36°	45°	54°	63°	72°	81°	90°	99°	108°	117°	126°	135°	144°	153°	162°	171°
56.2	55.6	54.0	51.2	47.0	41.8	35.5	28.7	21.6	14.5	8.2	4.6	4.5	5.3	5.4	5.4	3.2	0.6	0.6	0.6
100%	99%	96%	91%	84%	74%	63%	51%	38%	26%	15%	8%	8%	10%	10%	10%	6%	1%	1%	1%

Beam angle 50%	Field angle 10%	Cutoff angle 2,5%	Intensity ratio in 120° cone	Intensity ratio in 90° cone
127.4°	240.7°	299.4°	60.7%	39.9%